

POWER NETWORK METER **ND30IoT**



USER'S MANUAL



Contents

1 APPLICATION.....	2
2 METER SET.....	2
3 BASIC REQUIREMENTS, OPERATIONAL SAFETY.....	3
4 INSTALLATION.....	3
5 METER DESCRIPTION.....	4
5.1 Current inputs	4
5.2 Voltage inputs.....	4
5.3 External connection diagrams.....	5
6 ND30IoT Programming.....	8
6.1 Front panel.....	8
6.2 Starting work.....	10
7 OPERATING MODES.....	10
7.1 Measurement mode.....	14
7.1.1 Measurement of voltage and current harmonics.....	14
7.1.2 Analog indicator	15
7.2 Parameters mode.....	15
7.3 Alarms mode.....	18
7.4 Analog output mode.....	20
7.5 Display mode.....	21
7.6 Archiving mode.....	25
7.7 Ethernet mode.....	28
7.8 Modbus mode.....	30
7.9 Settings mode	30
7.10 Information mode	31
8 MEASURING VALUES ARCHIVING.....	32
8.1 INTERNAL MEMORY.....	32
8.2 COPYING ARCHIVE	32
8.3 ARCHIVE FILES STRUCTURE.....	33
8.4 DOWNLOADING ARCHIVE	34
9 SERIAL INTERFACES.....	34
9.1 RS485 INTERFACE – list of parameters.....	34
9.2 Examples of registers' readout and write.....	34
9.3 Ethernet interface 10/100-BASE-T.....	37
9.3.1 Connecting 10/100-BASE-T interface.....	38
9.3.2 Web Server.....	39
9.3.2.1 General view.....	39
9.3.2.2 Web user selection	40
9.3.3 FTP Server.....	40
9.3.3.1 FTP user selection.....	41
9.3.4 Modbus TCP/IP.....	43
9.3.5 MQTT protocol.....	43
10 MAP OF ND30IoT METER REGISTERS.....	45
11 SOFTWARE UPGRADE.....	64
11.1 Upgrade of the meter website.....	64
11.2 Firmware update - main program of the meter.....	65
12 ERROR CODES.....	66
13 TECHNICAL DATA.....	66
14 ORDERING CODE.....	69

1 APPLICATION

The ND30IoT meter is a programmable digital instrument designed for the measurement of 1-phase 2-wire and 3-phase 3 and 4-wire power network parameters in balanced or unbalanced systems. The measured values are displayed on a 3,5" TFT full-color screen, resolution: 320 x 240 pixel. The meter enables control and optimization of the power electronic devices, systems and industrial installations.

The meter provides measurement of: RMS of voltage and current, active, reactive and apparent power, active, reactive and apparent energy, power factors, frequency, the harmonics of current and voltage /up to 51st/, THD of voltage and current, averaged active and apparent power P Demand, S Demand, averaged current I Demand /15, 30 or 60 minutes/. Voltages and currents are multiplied by given voltage and current ratios of the measuring transformers. Power and energy indications take into account all programmed ratio values. The value of each measured value can be transmitted to the master system via the RS-485 or Ethernet interface. Three relay outputs signal the overflow of the chosen value and the programmable analog output maps the assigned parameter. The temperature inputs can be used to control the temperature of the transformers windings, motors.

There is a galvanic separation between following units of the meter:

- supply
- voltage inputs
- current inputs
- RS485 interface
- Ethernet interface
- alarm outputs
- analog output
- temperature input Pt100

2 METER SET

Complete set of the meter includes:

- | | |
|------------------------------------|-------|
| 1. ND30IoT meter | 1 pc |
| 2. seal | 1 pc |
| 3. screw clamp to fix in the panel | 4 pcs |
| 4. plug with 16 screw terminals | 1 pc |
| 5. plug with 14 screw terminals | 1 pc |
| 6. user's manual | 1 pc |



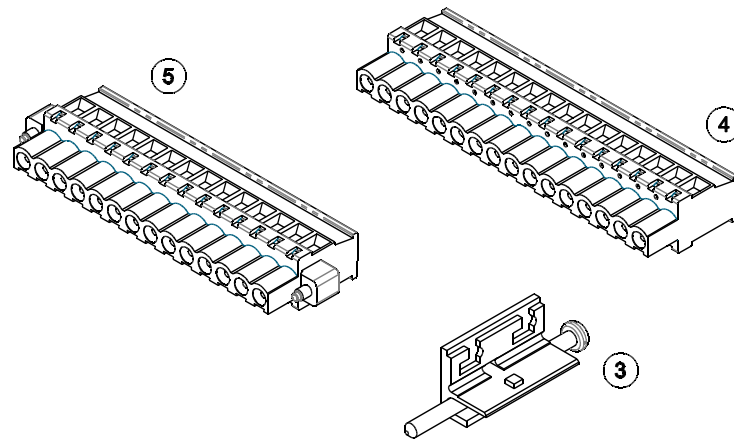

Fig. 1. Meter set

3 BASIC REQUIREMENTS, OPERATIONAL SAFETY

In terms of operational safety the controller meets the requirements of the EN 61010-1 standard.

Remarks concerning safety:

- The meter should be installed and connected only by a qualified personnel. All relevant safety measures should be observed during installation.
- Always check the connections before turning the meter on.
- Prior to taking the meter housing off, always turn the supply off and disconnect the measuring circuits.
- Removal of the meter housing during the warranty period voids the warranty.
- This meter conforms to all requirements of the electromagnetic compatibility in the industrial environment.
- A switch or a circuit-breaker should be installed in the building or facility. It should be located near the device, easily accessible by the operator, and suitably marked.

4 INSTALLATION

The meter is intended to be fixed to the panel with mounting brackets as presented on Fig. 1. The meter housing is made of a self-extinguishing plastics.

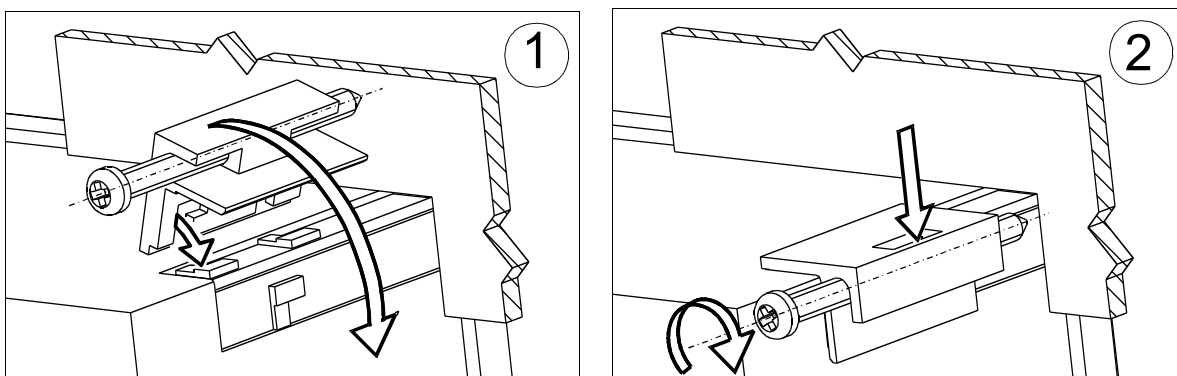

Fig. 2. Meter fitting

Housing overall dimensions 96 x 96 x 77 mm, dimensions of the assembly hole 92.5 x 92.5 mm.

There are screw terminal strips on the outer side of the meter which enable the connection of external wires of diameter up to 2.5 mm².

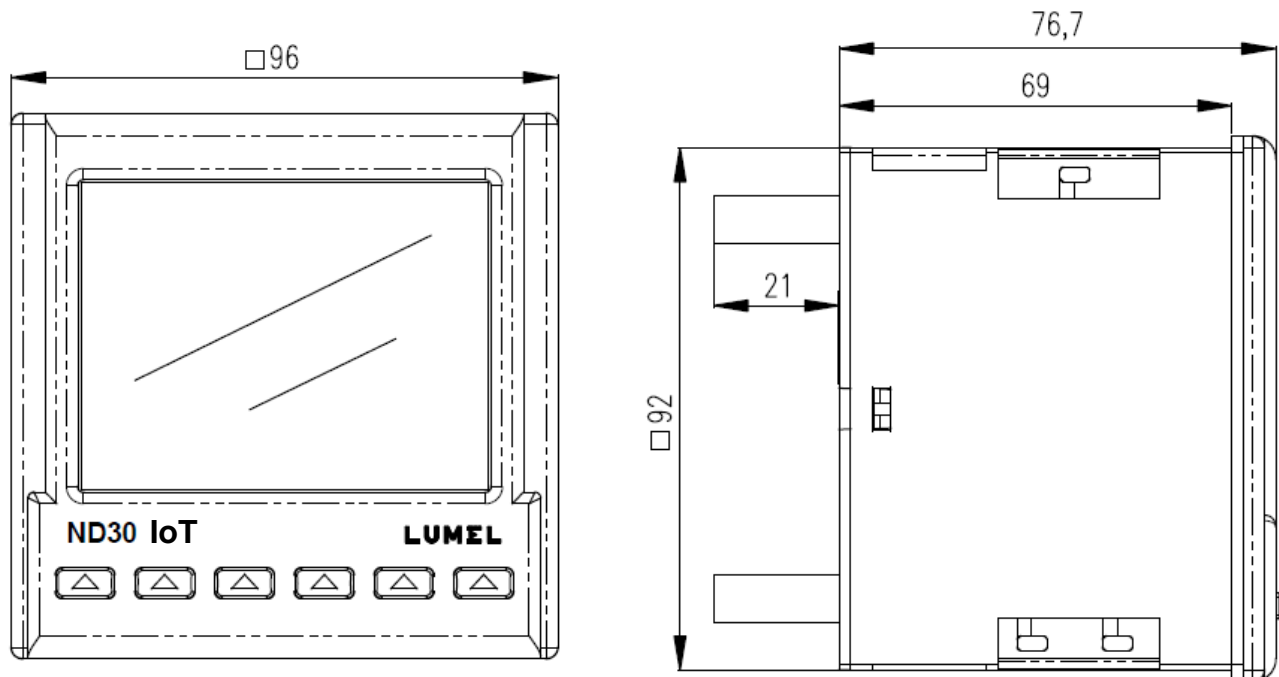

Fig. 3. Overall dimensions of the ND30IoT meter

5 METER DESCRIPTION

5.1 Current inputs

All current inputs are galvanically isolated (internal current transformers). The meter is adapted to work with external measuring current transformers / 1 A or 5 A /. Displayed current values and derivative values are automatically converted in relation to the introduced external current transformer ratio.

5.2 Voltage inputs

All voltage inputs are galvanically isolated (internal transformers). Values on voltage inputs are automatically converted according to the introduced ratio of the external voltage transformer. Voltage inputs are specified in the order as 3x57.7/100 V, 3x230/400 V or 3x110/190 V, 3x400/690 V.

5.3 External connection diagrams

External connections are shown in Fig. 4.

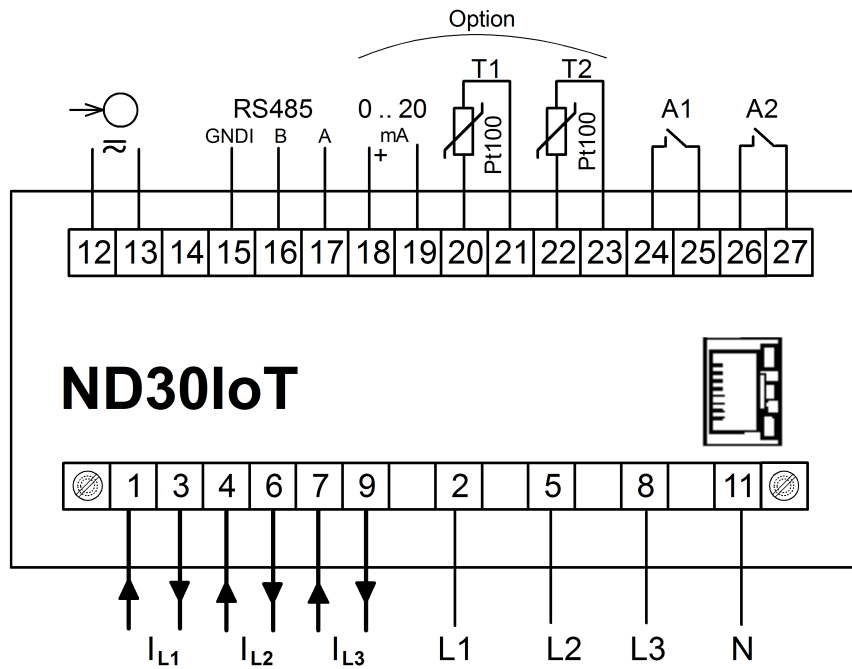

Fig. 4. Meter connections

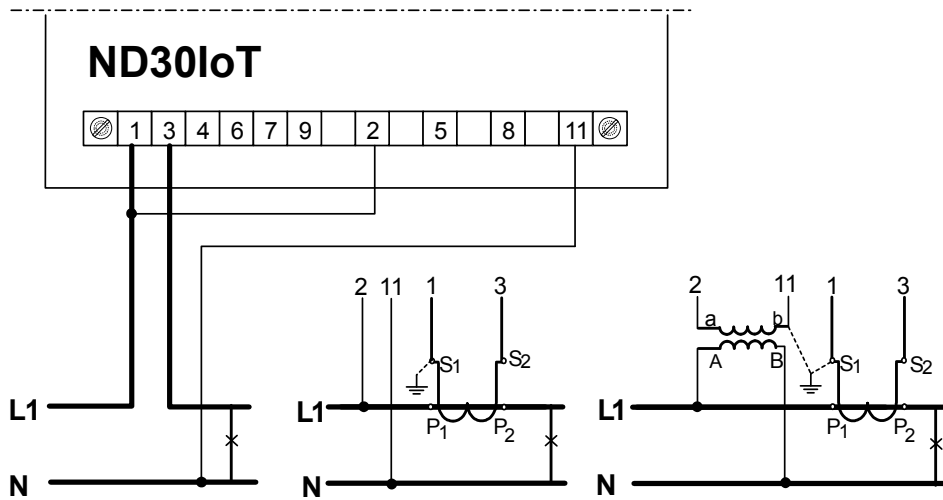
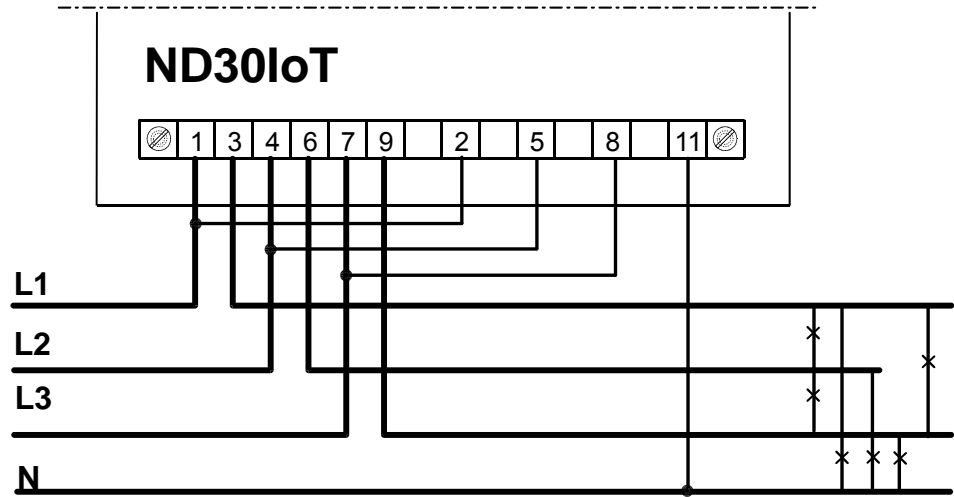
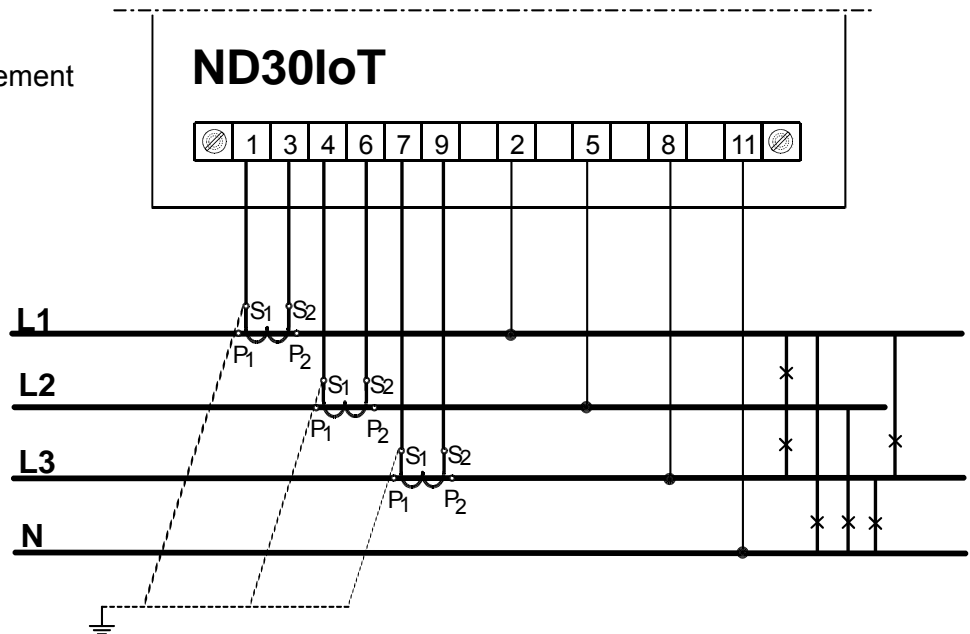

Fig. 5. Direct measurement, indirect and semi-indirect in a 1-phase network

Direct measurement
in 4-wire network



Semi-indirect measurement
in 4-wire network



Indirect measurement
in 4-wire network

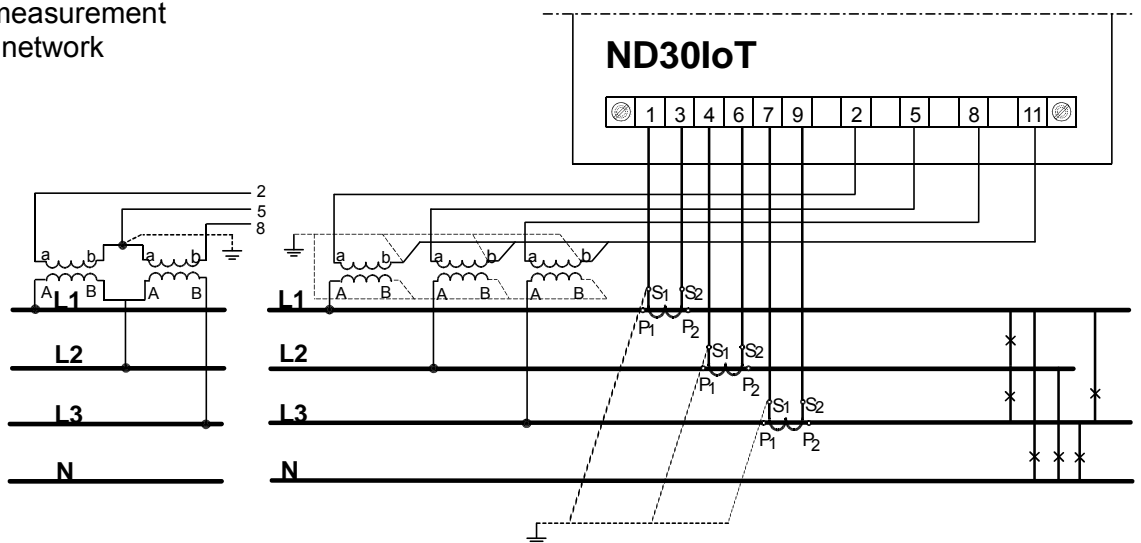
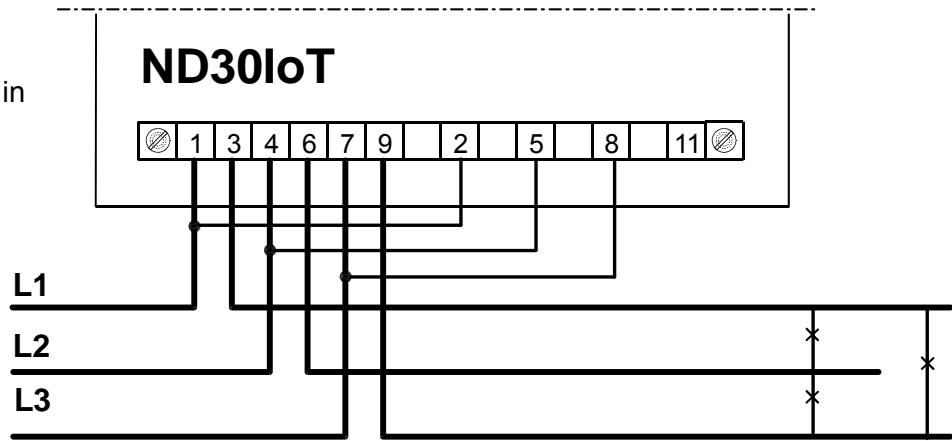
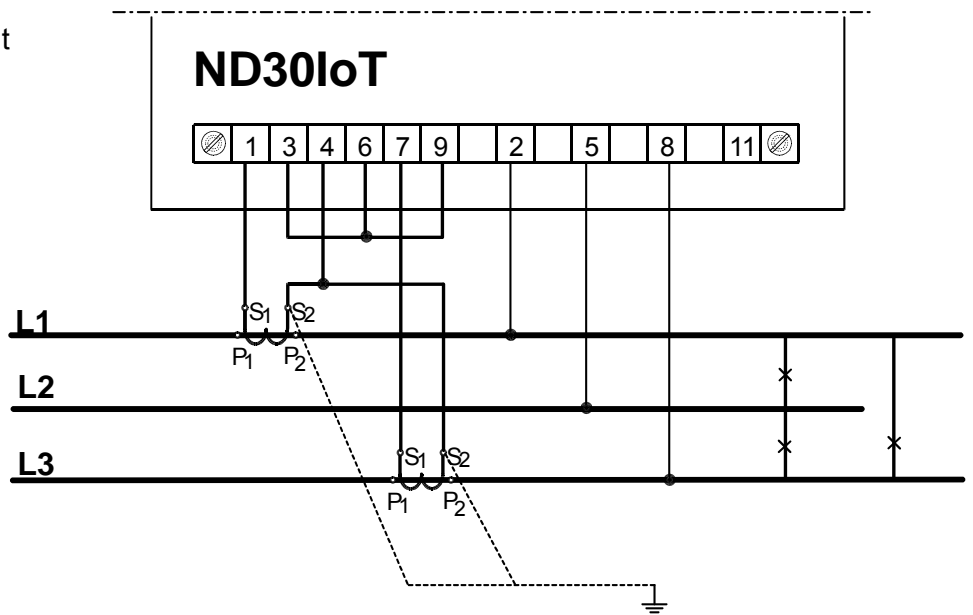

Fig. 6. Meter connections of input signals in a 3-phase 4-wire network

Direct measurement in a 3-wire network



Semi-indirect measurement using 2 current transformers in a 3-wire network



Indirect measurement using 2 current transformers and 2 or 3 voltage transformers in a 3-wire network

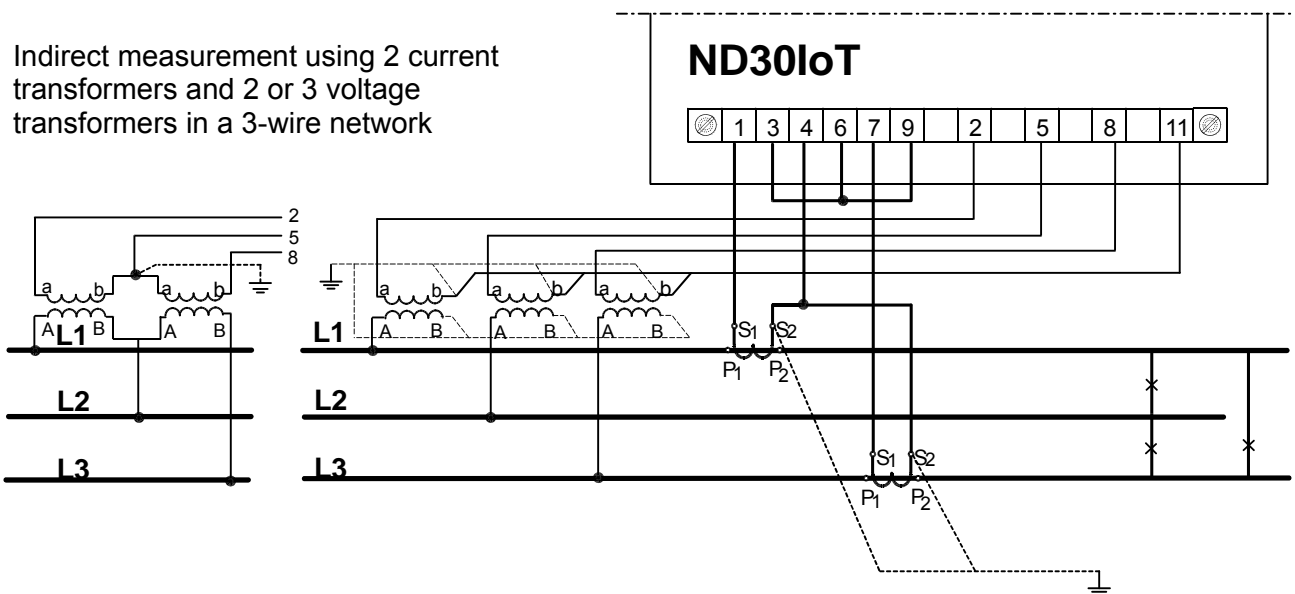

Fig. 7. Meter connections of input signals in a 3-phase 3-wire network

6 ND30IoT PROGRAMMING



6.1 Front panel



Fig. 8. Front panel

The ND30IoT meter has 6 buttons and a full-color graphic screen. Front panel description:

f1, ... , f8	8 field displays - the digits for readout and settings,	DMD	Averaged value indicator (Demand)
V, A, W, var, VA, Wh, varh, ..	units of the displayed values	k, M	kilo = 10 ³ ; Mega = 10 ⁶
U1, I1, P1, ... EnO	displayed parameters markings		The markers indicating the inductive, capacity load character

The values of the measured parameters are shown on the active pages selected by subsequent pressing the buttons  (next page) or  (previous page).

The page consists any 8 values selected from the Table 1 and displayed simultaneously on the display. The page definition is described in the **Display** mode. Depending on the location, meter buttons can perform different functions. Functions are described in the bar on the bottom of the screen. If the button lacks description, it is inactive at the moment.



Function of button 1	Function of button 2	Function of button 3	Function of button 4	Function of button 5	Function of button 6
Del		Min	Max		Menu

Fig. 9. Buttons marking – example

Information bar at the top of the screen displays the status of the alarm outputs, alarm conditions, T1 and T2 temperature of the sensors connected to the first and second input of PT100, files archive memory status, archive status, a symbol of Ethernet connection, the indicators of receiving and transmitting data on the RS485 link, date and real-time clock. A symbol "phase sequence error" will be blinking in case of a negative phase sequence.

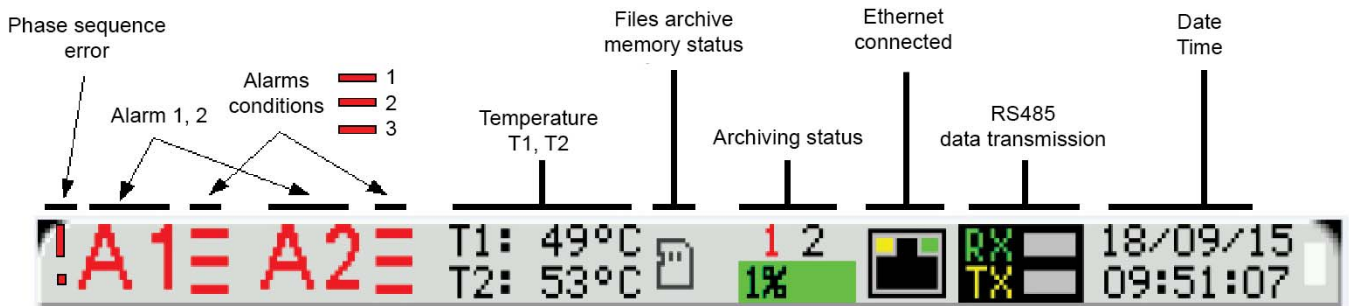

Fig. 10. Information bar

Icon	Icon color	Comments
	Black – archive memory mounted correctly	
	Black – no archive memory Red – wrong file system of the card	
	Copying from internal memory to files archive memory. The field of percentage of files archive memory used flashes blue while displaying the percentage of copying progress.	
	Current state of the archiving: Black – archiving in a group enabled, waiting for the archiving conditions to be met. Red – the archiving conditions have been met and saving the records is in progress. White – archiving in a group disabled.	1st archiving group 2nd archiving group
	Percentage of files archive memory used	
	Green background	Value in the range 0 ... 70%
	Orange background	70% of files archive space is full. It is recommended to remove unnecessary files via FTP.
	Red background	It is less than 7% of free space in the files archive memory left. Time to completely use a the files archive space is approximately 14 days at 1 sec. interval. Immediately delete any unnecessary files via FTP.
	Percentage of the archive copying progress.	
	Blue flashing background	Copying from internal memory to files archive memory in progress

6.2 Starting work

After switching the supply on, the meter displays the ND30IoT meter name, version, current software version and MAC for the version with Ethernet and then moves to the measurement mode and last saved page. Displayed information:

ND30IoT v:1.00 – meter type, program version number

Bootloader v.01.05 – bootloader version number

U: 57.7/230.0 V – voltage versions

I: 1.0/5.0 A – current versions

MAC: AA:BB:CC:DD:EE:FF

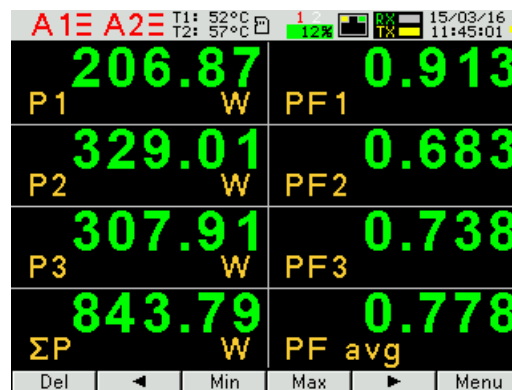

Fig. 11. Screen of meter measuring mode

7 OPERATING MODES

The ND30IoT meter has 10 operating modes:

Measure – normal work mode. In the **Measure** mode the values are displayed according to the pages that are preset at the factory or configured by the user.

Parameters – meter parameters configuration

Alarms – Alarm 1, Alarm 2 configuration

Analog output – analog output configuration

Display – displayed pages configuration

Archiving – archived values configuration

Ethernet – Ethernet interface configuration

Modbus – RS485 interface parameters configuration

Settings – settings: password, language, time, date

Information – preview of a program version, serial number, MAC address

To move from the **Measure** mode to any other mode, press the button **Menu** for approx. 3 seconds.

Buttons allow to select the appropriate mode, to accept press the button

To return to a measurement mode use the button

Parameters	Connection wire 3 phase - 4 wire 3 phase - 3 wire 1 phase - 2 wire	Current input range <input type="radio"/> 1 A <input checked="" type="radio"/> 5 A	Voltage input range <input type="radio"/> 3x57.7/100V <input checked="" type="radio"/> 3x230/400V or <input type="radio"/> 3x110/190V <input checked="" type="radio"/> 3x400/690V	Voltage transformer primary 0000 <u>1</u> 00	Voltage transformer secondary 00 <u>1</u> 00.0	Current transformer primary 0000 <u>5</u>	Current transformer secondary 000 <u>5</u>	Demand integ. time <input checked="" type="radio"/> 15 min <input type="radio"/> 30 min <input type="radio"/> 60 min	AVG synchronization <input checked="" type="radio"/> lack <input type="radio"/> with RTC	Pt100 resist on inp 1 PT100[Ω] 0000 <u>0</u> 0	Set parameters defaults <input checked="" type="radio"/> No <input type="radio"/> Yes
	Pt100 resist on inp 2 PT100[Ω] 0000 <u>0</u> 0	Voltage connector 2 <input checked="" type="radio"/> U1 <input type="radio"/> U2 <input type="radio"/> U3	Voltage connector 5 <input type="radio"/> U1 <input checked="" type="radio"/> U2 <input type="radio"/> U3	Voltage connector 8 <input type="radio"/> U1 <input type="radio"/> U2 <input checked="" type="radio"/> U3	Current connector 1-3 <input checked="" type="radio"/> I1 <input type="radio"/> -I1 <input type="radio"/> I2 <input type="radio"/> -I2 <input type="radio"/> I3 <input type="radio"/> -I3	Current connector 4-6 <input type="radio"/> I1 <input type="radio"/> -I1 <input checked="" type="radio"/> I2 <input type="radio"/> -I2 <input type="radio"/> I3 <input type="radio"/> -I3	Current connector 7-9 <input type="radio"/> I1 <input type="radio"/> -I1 <input type="radio"/> I2 <input type="radio"/> -I2 <input checked="" type="radio"/> I3 <input type="radio"/> -I3	Delete energy counters <input checked="" type="radio"/> No <input type="radio"/> active <input type="radio"/> reactive <input type="radio"/> apparent <input type="radio"/> all	Delete demand values <input checked="" type="radio"/> No <input type="radio"/> Yes	Set parameters defaults <input checked="" type="radio"/> No <input type="radio"/> Yes	
Alarms	Settings	Logical conditions <input checked="" type="radio"/> C1 <input type="radio"/> C1 v C2 v C3 <input type="radio"/> C1 ^ C2 ^ C3 <input type="radio"/> C1 ^ C2 v C3 <input type="radio"/> (C1 v C2) ^ C3	Relay state if alarm on <input type="radio"/> off <input checked="" type="radio"/> on	Holdback alarm off <input checked="" type="radio"/> off <input type="radio"/> on	Display alarm event <input checked="" type="radio"/> off <input type="radio"/> on	Set defaults <input checked="" type="radio"/> No <input type="radio"/> Yes					
	Alarm 1 Alarm 2	Condition C1 Condition C2 Condition C3	Value <input checked="" type="radio"/> U1 <input type="radio"/> I1 <input type="radio"/> P1 <input type="radio"/> Q1 : <input type="radio"/> hh:mm	Condition type <input checked="" type="radio"/> n_on <input type="radio"/> noFF <input type="radio"/> on <input type="radio"/> oFF <input type="radio"/> H_on : <input type="radio"/> 3_oF	Low limit condition [%] +009 <u>9</u> 0	High limit condition [%] +010 <u>1</u> 0	Delay to condition on [s] 000 <u>0</u>	Delay to condition off [s] 000 <u>0</u>	Holdback condition off->on [s] 000 <u>0</u>	Display condition event <input checked="" type="radio"/> off <input type="radio"/> on	
Analog output	Value <input type="radio"/> U1 <input checked="" type="radio"/> I1 <input type="radio"/> P1 <input type="radio"/> Q1 : : <input type="radio"/> hh:mm	Output range <input checked="" type="radio"/> 0..20mA <input type="radio"/> 4..20mA	Low limit input [%] +000 <u>0</u>	High limit input [%] +100 <u>0</u>	Low limit output [mA] 0.0 <u>0</u>	High limit output [mA] 20.0 <u>0</u>	Out mode <input checked="" type="radio"/> normal <input type="radio"/> Low limit output <input type="radio"/> High limit output	Set defaults <input checked="" type="radio"/> No <input type="radio"/> Yes			

Fig. 12a. Programming matrix

Displaying	Settings	Backlight level <input type="radio"/> Minimum <input type="radio"/> Medium <input checked="" type="radio"/> Maximum	Time to Backlight level min [s] 000 <u>0</u>	Pages cfg <input checked="" type="radio"/> page 1 <input checked="" type="radio"/> page 2 <input checked="" type="radio"/> page 3 : <input checked="" type="radio"/> page 12	Pages color <input checked="" type="radio"/> green <input type="radio"/> red <input type="radio"/> yellow : <input type="radio"/> olive	Set page defaults <input checked="" type="radio"/> No <input type="radio"/> Yes	
	Page 1 : Page 10	Display field 1 Display field 2 : : Display field 8	Displayed value <input type="radio"/> Off <input checked="" type="radio"/> U1 <input type="radio"/> I1 <input type="radio"/> P1 <input type="radio"/> Q1 : <input type="radio"/> En S				
	Page 13	Displayed value <input type="radio"/> Off <input checked="" type="radio"/> U1 <input type="radio"/> I1 <input type="radio"/> P1 <input type="radio"/> Q1 : <input type="radio"/> T2	Bottom scale [%] -0144. <u>0</u>	Upper scale [%] +0144. <u>0</u>			

Fig. 12b. Programming matrix

Archiving	Group 1 Group 2	Archive type <input checked="" type="radio"/> n_on <input type="radio"/> noFF <input type="radio"/> on <input type="radio"/> oFF <input type="radio"/> H_on : <input type="radio"/> 3_oF	Parameters <input type="radio"/> U1 <input type="radio"/> I1 <input type="radio"/> P1 <input type="radio"/> Q1 : <input type="radio"/> T2	Trigger <input checked="" type="radio"/> U1 <input type="radio"/> I1 <input type="radio"/> P1 <input type="radio"/> Q1 : <input type="radio"/> time	Interval [s] 000 <u>1</u>	Archive low [%] +0000 <u>0</u>	Archive high [%] +0000 <u>0</u>
	CSV settings	Value separator <input checked="" type="radio"/> comma <input type="radio"/> semicolon <input type="radio"/> tabulator	Decimal separator <input checked="" type="radio"/> dot <input type="radio"/> comma				
	Actions	Copy archive to a CSV file <input checked="" type="radio"/> No <input type="radio"/> Yes	Clear archive <input checked="" type="radio"/> No <input type="radio"/> Yes				

Fig. 12c. Programming matrix

Ethernet	Addresses	DHCP <input type="radio"/> Deact. <input checked="" type="radio"/> Act.	Mode <input checked="" type="radio"/> Auto <input type="radio"/> 10Mb/s <input type="radio"/> 100Mb/s	IP Address 000.000.000.000	Subnet mask 255.255.255.000	Gateway address 000.000.000.000	DNS Address 008.008.008.008	MAC Address aa.bb.cc.00.21.01	
	Acquired from DHCP or entered manually when DHCP is deactivated.								
	Modbus TCP	Address 001	Port 00502	Max. connection limit 1	Waiting time [s] 001				
	FTP	Command port 00021	Data port 01025						
	WWW	Port 00080							
MQTT	Connection status - Disconnected - Connecting - Connected	IP Address 000.000.000.000	Port no. 01883	Publish time [s] 0005	Client name ND30-MQTT-CLIENT	Topic Name ND30-MEAS-TOPIC	MQTT On / Off <input checked="" type="radio"/> Deact. <input type="radio"/> Act.	Save to FRAM <input checked="" type="radio"/> No <input type="radio"/> Yes	



Fig. 12d. Programming matrix







Modbus	Address 001	Baudrate <input type="radio"/> 4800b/s <input checked="" type="radio"/> 9600b/s <input type="radio"/> 19,2 kb/s <input type="radio"/> 38,4 kb/s <input type="radio"/> 57,6 kb/s <input type="radio"/> 115,2 kb/s	Mode <input checked="" type="radio"/> RTU8N2 <input type="radio"/> RTU8N1 <input type="radio"/> RTU8O1 <input type="radio"/> RTU8N1	Default settings reg. 42xx <input checked="" type="radio"/> No <input type="radio"/> Yes							
	Settings	Password ****	Language <input type="radio"/> English <input checked="" type="radio"/> Polski <input type="radio"/> Deutsch	Time 13.4Z	Date 08/09/2015	Default settings <input checked="" type="radio"/> No <input type="radio"/> Yes					
Information	Type ND30	Ordering code 12200	Loader version 1.05	Program version 0.60	Serial number 18030006	MAC address aa.bb.cc.00:21:01	DHCP <input type="radio"/> Off <input checked="" type="radio"/> On	IP Address 000.000.000.000	Subnet mask 255.255.255.000	Deafult Gateway 000.000.000.000	DNS Address 008.008.008.008
	obtained from DHCP or entered manually when DHCP is off										

Fig. 12e. Programming matrix

7.1 Measurement mode

In the **Measure** mode the values are displayed according to the pages that are preset at the factory or configured by the user in the **Display** mode.

Changing the page is done by pressing the buttons  or .

Preview of the maximum or minimum values respectively is done while the button  or  is pressed down. Reset of maximum or minimum values is done by pressing the button  while viewing their values, i.e. first the button  or  and then  must be pressed.

Simultaneously pressing the button  and  will copy internal memory to files archive.

When reactive power or reactive inductive or capacity energy is displayed, this indication is accompanied by a symbol of the load character: ξ for an inductive load or \oplus for a capacity load.



When displaying the active power, the sign "+" is displayed for active energy import or "-" for active energy export.

Exceeding of the upper or lower indication range is signaled on the display by $\wedge\wedge\wedge\wedge$ or $\vee\vee\vee\vee$. For measurement of the averaged values (P DMD, S DMD, I DMD) single measurements are carried out with 0.25 second quantum. Averaging time to choose from: 15, 30 or 60 minutes. Until all samples of the averaged values are acquired, the values are calculated from already measured samples.



Current value in the neutral wire IN is calculated from phase current vectors.

7.1.1 Measurement of voltage and current harmonics

The choice of harmonics is done by selecting the pages dedicated to display the values of voltage harmonics U1, U2, U3 and currents I1, I2, I3 simultaneously for 3-phase (page 11). The

number of a displayed harmonics can be changed in the range of 2..51 by the buttons  or .

Page 12 shows a bar chart of the harmonics for each phase: voltage at the top and currents at the bottom of the screen. Page 12 shows a bar chart of the harmonics. The choice of displayed

harmonics is done by pressing a button . The button  is used to select the groups of harmonics: harm₂ - harm₂₆, harm₂₇ - harm₅₂ or harm₂ - harm₅₁.

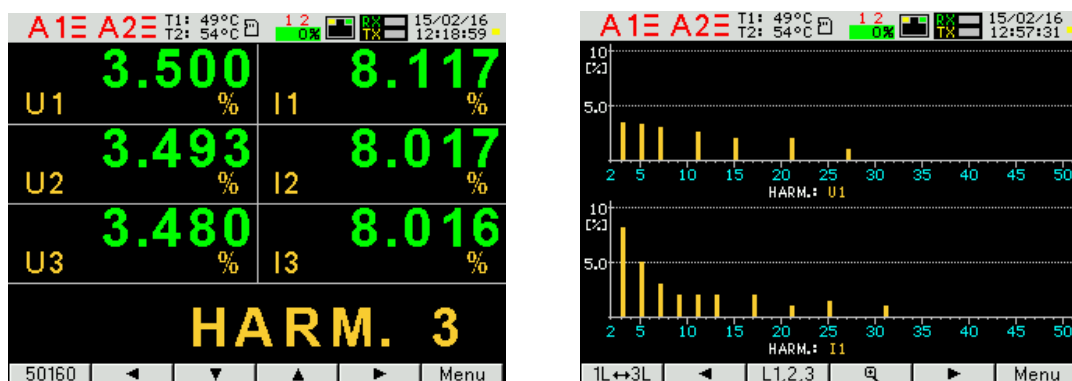

Fig. 13. Screens 11 and 12 - visualization of harmonics

7.1.2 Analog indicator

Page 13 shows the mapping of the selected quantity on the analog indicator. The selection of displayed quantity is made in the Display mode as described in item 7.5, by selecting page 13. Preview or hiding of the maximum or minimum values takes place after pressing the **Max** or **Min** button respectively. Deleting the maximum or minimum values is done by pressing the **Del** and then **Max** or **Min** button. If the lower or upper scale threshold is exceeded, the message BOTTOM SCALE or UPPER SCALE appears.

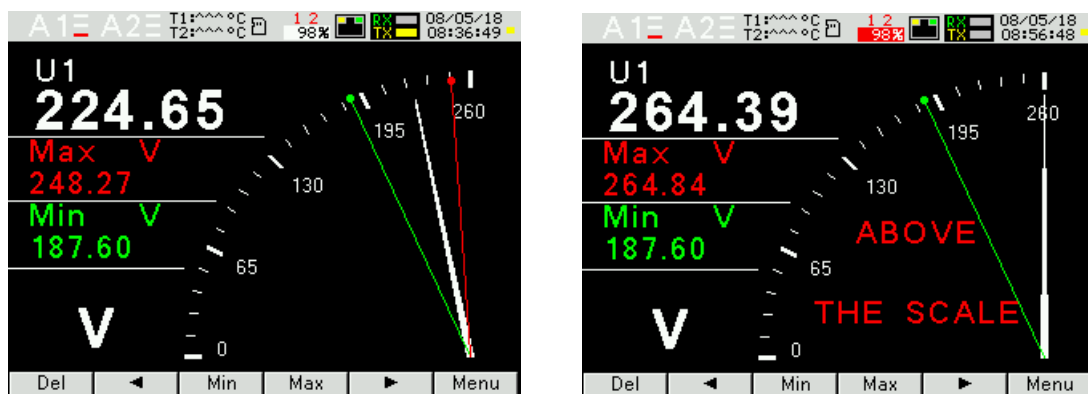

Fig.13a. Screen 13 - visualization of the analog indicator

7.2 Parameters mode

This mode is used to determine the parameters of the meter. To enter Parameters mode press the button **Menu** for approx. 3 seconds and next using the button **▲** or **▼** select Parameters mode, to accept press the button **Select**. The parameters configuration mode is protected by a password, if it was entered and it is different from zero. The password prompt is skipped for the password 0000. If the password is incorrect, the message "Wrong password. Read only menu" is displayed. Then it is possible to view the parameters, but the changes are not possible.

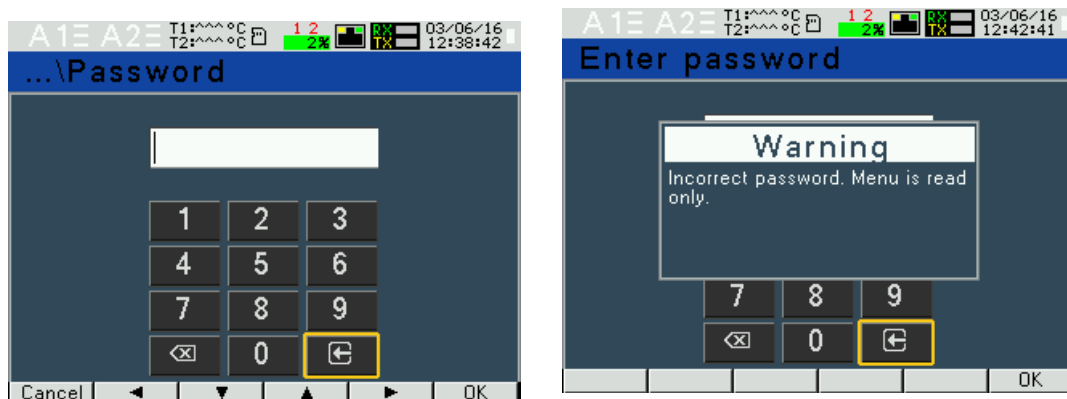







Fig. 14. Screens while entering a password

If the password is correct or it has not been entered, you can set the values according to Table 2. Buttons **▲** **▼** are used to choose the parameter, to accept press the button **Select**.

Then use the buttons   to choose the features of a parameter or set the requested parameter values, i.e. you can choose the digit in the decimal position by the button  or  the digit value by the button  or . The active position is signaled by the cursor. Set value or parameter can be accepted by the button **OK** or canceled by pressing **Cancel**. Exit from the Parameters procedure follows pressing simultaneously the button **Esc** or after waiting for approx. 120 seconds. Exit from the Selecting parameters menu follows pressing the button **Exit** or after waiting for approx. 120 seconds.



Measurement



Menu button min. 3 sec.

Button Select

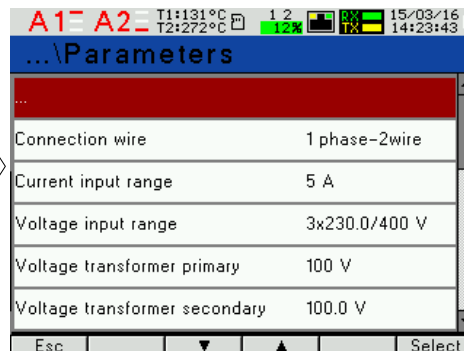

The buttons

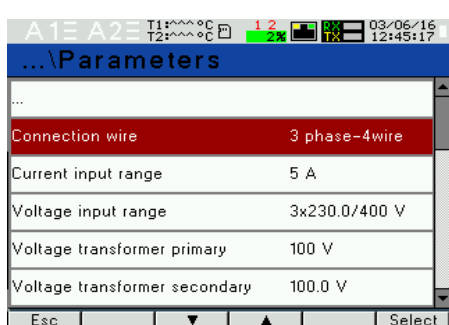
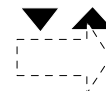

Button Select

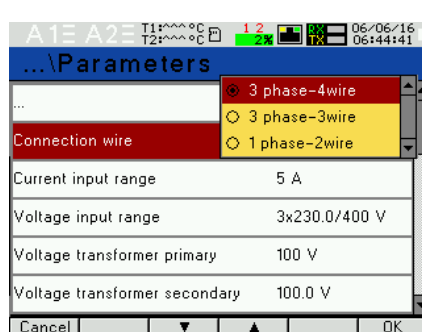

choice of the features
OK - acceptance
Cancel - resignation

Fig. 15. Screens of Parameters mode

Table 1

Item	Parameter name	Feature / value	Description	Default settings
1	Connection wire	3 phase -4 wire 3 phase -3 wire 1 phase -2 wire	Type of power network 3-phase 4-wire 3-phase 3-wire 1-phase 2-wire	3 phase -4 wire
2	Current input range	1A, 5A	Input range: 1A or 5A	5A
3	Voltage input range	3x57.7/100 V; 3x230/400 V; or 3x110/190 V; 3x400/690 V;	Choice of the ranges depending on the ordering code	3x230/400 V or 3x400/690 V
4	Voltage transformer primary	1 .. 1245183 V		100
5	Voltage transformer secondary	0.1 .. 01000.0		100.0
6	Current transformer primary	1...20000		5
7	Current transformer secondary	1...1000		5
8	Demand integ. time	15 min, 30 min, 60 min	Averaging time active power P DMD, apparent power S DMD, current I DMD	15 min
9	AVG synchronization	none, with RTC	Averaging synchronized with the real-time clock	none
10	PT100 resist on inp 1	0000.00	Resistance value in Ω	0.00 Ω
11	PT100 resist on inp 2	0000.00	Resistance value in Ω	0.00 Ω
12	Voltage connector 2	U1, U2, U3		U1
13	Voltage connector 5	U1, U2, U3		U2
14	Voltage connector 8	U1, U2, U3		U3
15	Current connector 1-3	I1,-I1,I2,-I2,I3,-I3		I1
16	Current connector 4-6	I1,-I1,I2,-I2,I3,-I3		I2
17	Current connector 7-9	I1,-I1,I2,-I2,I3,-I3		I3
18	Delete energy counters	No, Active, Reactive, Apparent, All		No
19	Delete demand values	No, Yes		No
20	Default parameters	No, Yes		No

During changing the parameter, it is check if the value is in the range. If the set value falls outside the allowable range, the value is set to the maximum value (when entered value is too high) or minimum value (when it is too low).

Free eCon software can also be used for configuration of the ND30IoT meters, it is available on the website www.lumel.com.pl.

7.3 Alarms mode

In the options, select the **Alarms** mode and confirm selection by pressing the button **Select**.

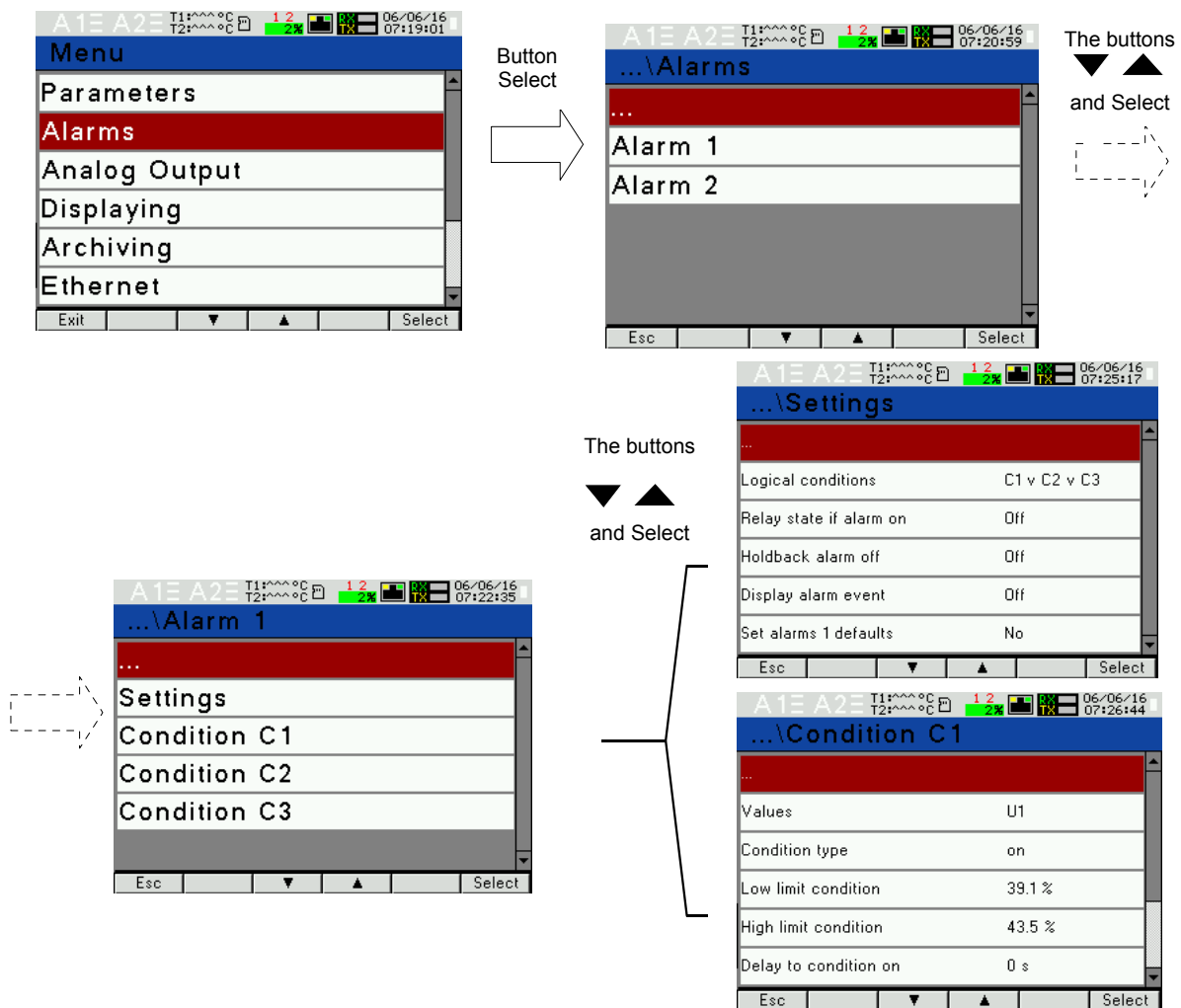

Fig. 16. Screens of Alarms mode

Table 2

Item		Parameter name	Range	Notes/description	Default settings
1	Settings	Logical conditions	C1 C1 v C2 v C3 C1 ^ C2 ^ C3 (C1 ^ C2) v C3 (C1 v C2) ^ C3		C1
2		Relay state if alarm on	Off/On	State of the relay at the alarm switched on Off/On	On
3		Holdback alarm off	Off/On		Off
4		Display alarm event	Off/On	When alarm indication function is enabled and the alarm state ends, alarm symbol is not turned off but begins to flash. Signalization symbol flashes until it is turned off by pressing the button Del and Alarm (> 1 sec.). This function refers only to the alarm signalization, so the relay contacts will operate without a latch according to the selected alarm type.	Off

		Values	U1, I1,...,T2, hh:mm	Value on the alarm output parameters acc. to Table 8	U1
6	Condition 2	Condition type	n_on, noFF, on,oFF, H_on, HoFF, 3non, 3noF, 3_on, 3_oF	Acc. to Fig.17.	n-on
7		Low limit condition	-144.0...144.0	in % of the rated input value	90.0
8		High limit condition	-144.0...144.0	in % of the rated input value	110.0
9		Delay to condition on	0 ... 3600	in seconds	0
10		Delay to condition off	0 ... 3600	in seconds	0
11		Holdback condition off->on	0 ... 3600	in seconds	0
12		Display condition event	Off/On	When a latch function is enabled and the condition state ends, condition symbol is not turned off but begins to flash. Signalization symbol flashes until it is turned off by pressing the button Cancel and Alarm (> 3 sec.).	Off

Entering "Condition upper value" lower then "Condition lower value" disables a condition.

a) n_on

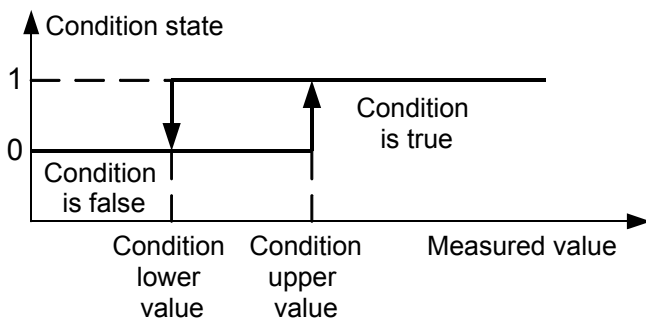

b) noFF

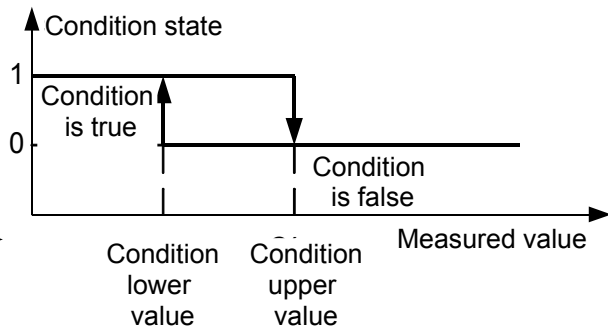

c) on

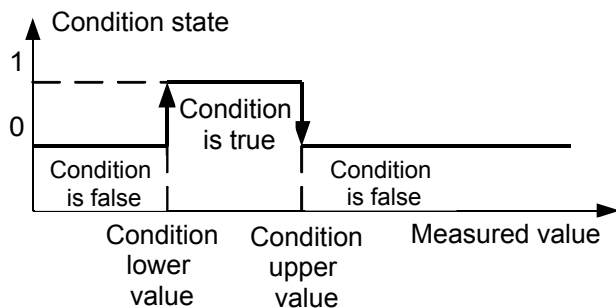

d) oFF

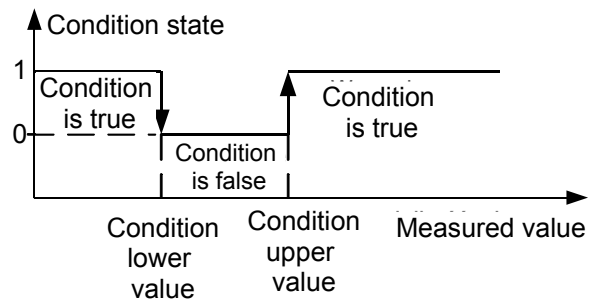

Fig. 17. Condition types: a) n_on b) noFF c) on d) OFF

Remaining types of the condition:

- **H_on** – always true;
- **HoFF** – always not true,
- **3non** – when the measuring value on any phase exceeds the "Condition upper value" - condition is true. The condition will be disabled if the measuring value on all phases will be lower than "Condition lower value".
- **3noF** – when the measuring value on any phase will be lower than the "Condition lower value" - condition is true. The condition will be disabled if the measuring value on all phases will be higher than "Condition upper value".
- **3_on** – when the measuring value on any phase will be between the "Condition lower value" and "Condition upper value" - condition is true. The condition will be disabled if the measuring value on all phases will be below "Condition lower value" or above "Condition upper value".
- **3_oF** – when the measuring value on any phase will be below the "Condition lower value" or above "Condition upper value" - condition is true. The condition will be disabled if the measuring value on all phases will be between the "Condition lower value" and "Condition upper value".
- The alarm value in the series 3 alarms must be in the range: 01-09, 10-18 and 19-27 (acc. to Table 8). They work with identical thresholds "Condition lower value" and "Condition upper value" for each phase. The blanking of the alarm signalization latch follows pressing the buttons **Del** and **Alarm** (> 3 sec.).

7.4 Analog output mode

In the options, select the **Analog output** mode and confirm selection by pressing the button **Select**.

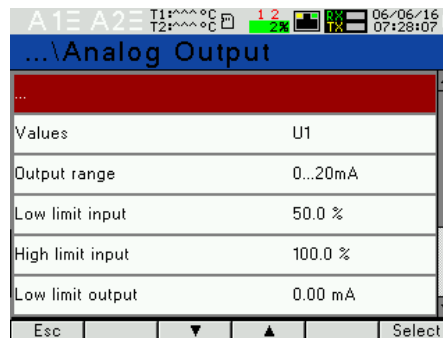

Fig.18. Screens of Analog output mode

Table 3

Item	Parameter name	Feature / value	Description	Default settings
1	Value	U1, I1,...,T2, hh:mm	Value on analog output parameter acc. to Table 8	ΣP
2	Output range	0...20 mA, 4...20 mA,	Analog output range	0...20 mA
3	Low limit input	-144.0 .. 144.0%	Lower value of the input range in % of the rated range	0.0
4	High limit input	-144.0 .. 144.0%	Upper value of the input range in % of the rated range	100.0

5	Low limit output	00.00 .. 24.00	Lower value of the output range in mA	0.00
6	High limit output	0.01 .. 24.00	Upper value of the output range in mA	20.00
7	Out mode	Normal Low limit output High limit output	Continuous output working mode	Normal

7.5 Display mode

In this mode, you can configure the pages displayed in a normal work mode of the meter Measurement

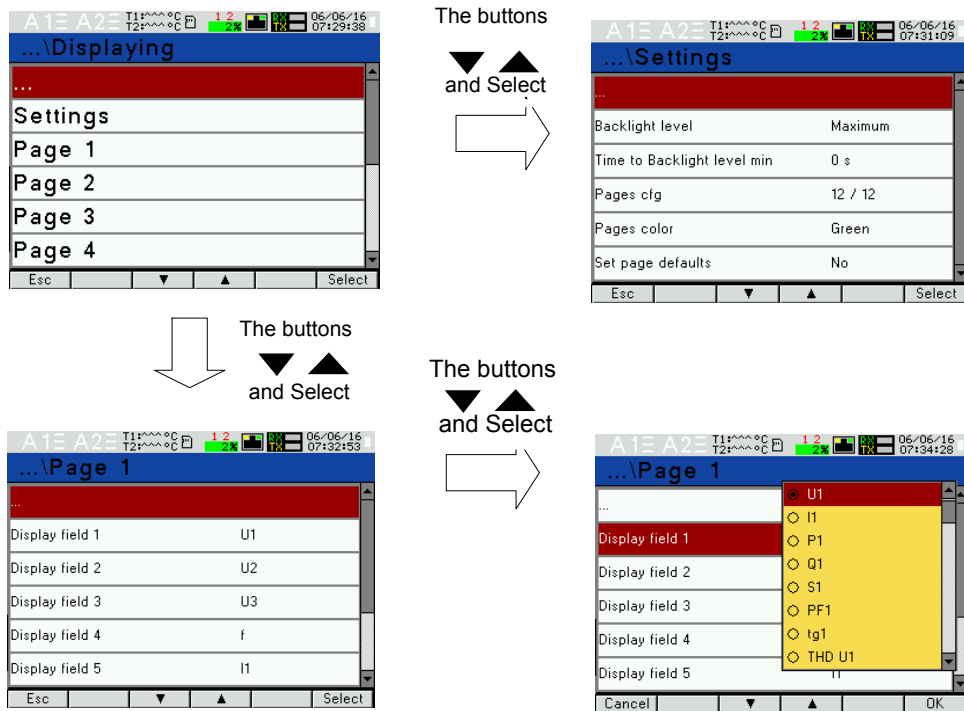

Fig. 19. Screens of Display mode

Table 4

Item		Parameter name	Range	Notes/description	Default settings
1	Settings	Backlight level	Minimum, Medium, Maximum		Maximum
		Time to Backlight level min	0 .. 9999	in seconds	0
		Pages cfg	Page 1 Page 2 : Page 11 Page 12	Selection of pages visualized in Measurement mode	Page 1 Page 2 : Page 11 Page 12
2		Pages color	Green Red Yellow : Olive	Color of displayed values in Measurement mode	Green
3		Display field 1	No Yes		No

4	Page 1 ⋮ Page 10	Display field 1 ⋮ Display field 8	Off U1 I1 P1 Q1 ⋮ En S	Selection of displayed values on a selected page and selected field acc. to Table 5.	Table 6a or 6b or 6c - depending on the connection system
5	Page 13	Displayed value	Off U1 I1 ⋮ T2	Selection of the visualized quantity on the analogue indicator according to table 5	U1
		Bottom scale	-0144.0	The lower value of the analog indicator scale	0.0
		Upper scale	+0144.0	The upper value of the analog indicator scale	100.0

Selection of displayed values:

Table 5

Item	value name	marking	unit	Signaling	3Ph / 4W	3Ph / 3W	1Ph / 2W
00	no value - blanked display field	Off			√	√	√
01	L1 phase voltage	U1	(M, k)V		√	x	√
02	L1 phase wire current	I1	(k)A		√	√	√
03	L1 phase active power	P1	(G, M, k)W		√	x	√
04	L1 phase reactive power	Q1	(G, M, k)var	ξ / ⚡	√	x	√
05	L1 phase apparent power	S1	(G, M, k)VA		√	x	√
06	L1 phase active power factor (PF1=P1/S1)	PF1			√	x	√
07	tgφ factor of L1 phase (tg1=Q1/P1)	tg1			√	x	√
08	L1 phase voltage THD*	THD U1	%		√	√	√
09	L1 phase current THD	THD I1	%		√	√	√
10	L2 phase voltage	U2	(M,k)V		√	x	x
11	L2 phase wire current	I2	(k)A		√	√	x
12	L2 phase active power	P2	(G, M, k)W		√	x	x
13	L2 phase reactive power	Q2	(G, M, k)var	ξ / ⚡	√	x	x
14	L2 phase apparent power	S2	(G, M, k)VA		√	x	x
15	L2 phase active power factor (PF2=P2/S2)	PF2	PF		√	x	x
16	tgφ factor of L2 phase (tg2=Q2/P2)	tg2			√	x	x
17	L2 phase voltage THD*	THD U2	%		√	√	x

18	L2 phase current THD	THD I2	%		√	√	x
19	L3 phase voltage	U3	(M,k)V		√	x	x
20	L3 phase wire current	I3	(k)A		√	√	x
21	L3 phase active power	P3	(G, M, k)W		√	x	x
22	L3 phase reactive power	Q3	(G, M, k)var	ξ / ⊕	√	x	x
23	L3 phase apparent power	S3	(G, M, k)VA		√	x	x
24	L3 phase active power factor (PF3=P3/S3)	PF3			√	x	x
25	tg* factor of L3 phase (tg3=Q3/P3)	tg3			√	x	x
26	L3 phase voltage THD*	THD U3	V%		√	√	x
27	L3 phase current THD	THD I3	A%		√	√	x
28	mean phase voltage	U avg	(M, k)V		√	x	x
29	mean 3-phase current	I avg	(k)A		√	√	x
30	3-phase active power	ΣP	(G, M, k)W	+/-	√	√	√
31	3-phase reactive power	ΣQ	(G, M, k)var	ξ / ⊕	√	√	√
32	3-phase apparent power	ΣS	(G, M, k)VA		√	√	√
33	active power factor 3-phase (PF=P/S)	PF avg			√	√	x
34	tgφ factor average for 3 phases (tg=Q/P)	tg avg			√	√	x
35	THD U mean 3-phase*	THD U	%		√	√	x
36	THD I mean 3-phase	THD I	%		√	√	x
37	frequency	f	Hz		√	√	√
38	phase-to-phase voltage L1-L2	U12	(M,k)V		√	√	x
39	phase-to-phase voltage L2-L3	U23	(M,k)V		√	√	x
40	phase-to-phase voltage L3-L1	U31	(M,k)V		√	√	x
41	mean phase-to-phase voltage	U123	(M,k)V		√	√	x
42	active power averaged (P Demand)	P DMD	(G, M, k)W		√	√	√
43	apparent power averaged (S Demand)	S DMD	(G, M, k)VA		√	√	√
44	current averaged (I Demand)	I DMD	(k)A		√	√	√
45	neutral wire current	I N	(k)A		√	x	x
46	Temperature T1 of input 1	T1	°C		√	√	√
47	Temperature T2 of input 2	T2	°C		√	√	√
48	3-phase imported active energy **	En P+	kWh		√	√	√
49	3-phase exported active energy **	En P-	kWh		√	√	√
50	3-phase reactive inductive energy **	En Q ξ	kvarh		√	√	√
51	3-phase reactive capacitive energy**	En Q ⊕	kvarh		√	√	√
52	3-phase apparent energy**	En S	kVAh		√	√	√

* In the 3-phase 3-wire system (3Ph / 3W) respectively THD U12, THD U23, THD U31, THD U123

** The quantities can not be visualized on the analogue indicator

Default settings of the displayed pages in 3-phase 4-wire system
Table 6a

P1		P2		P3		P4		P5	
U1 V	I1 A	U12 V	ΣP W	P1 W	PF1	P1 W	Q1 var	THD U1 %	THD I1 %
U2 V	I2 A	U23 V	ΣQ var	P2 W	PF2	P2 W	Q2 var	THD U2 %	THD I2 %
U3 V	I3 A	U31 V	ΣS VA	P3 W	PF3	P3 W	Q3 var	THD U3 %	THD I3 %
f Hz	I avg A	U123 V	PF avg	ΣP W	PF avg	ΣP W	ΣQ var	THD U %	THD I %
P6		P7		P8		P9		P10	
U1 V	S1 VA	U2 V	S2 VA	U3 V	S3 VA	ΣP W	P DMD W	ΣP W	+En P kWh
I1 A	PF1	I2 A	PF2	I3 A	PF3	ΣQ var	S DMD W	ΣQ var	-En P kWh
P1 W	tg1	P2 W	tg2	P3 W	tg3	I avg A	I DMD A	ΣS VA	En Q ξ kvarh
Q1 var	f Hz	Q2 var	f Hz	Q3 var	f Hz	I(N) A	f Hz	En S kVAh	En Q \oplus kvarh
P11		P12							
U1 %	I1 %	HARM.:U1U2U3 % bargraf							
U2 %	I2 %								
U3 %	I3 %	HARM.:I1I2I3 % bargraf							
HARM.2..51									

Pages 11 and 12 cannot be configured.

Default settings of the displayed pages in 3-phase 3-wire system
Table 6b

P1		P2		P3		P4		P5	
U12 V	I1 A	U12 V	ΣP W	ΣP W	P DMD W	THD U12 %	THD I1 %	ΣP W	En P+ kWh
U23 V	I2 A	U23 V	ΣQ var	ΣQ var	S DMD W	THD U23 %	THD I2 %	ΣQ var	En P- kWh
U31 V	I3 A	U31 V	ΣS VA	I avg A	I DMD A	THD U31 %	THD I3 %	ΣS VA	En Q ξ kvarh
f Hz	I avg A	U123 V	PF avg	tg avg	PF avg	THD U123 %	THD I %	En S kVAh	En Q \oplus kvarh

Default settings of the displayed pages in 1-phase system Table 6c

P1		P2		P3	
U1 V	S1 VA	P1 W	P DMD W	P1 W	En P+ kWh
I1 A	PF1	S1 VA	S DMD W	Q1 var	En P- kWh
P1 W	tg1	I1 A	I DMD A	S1 VA	En Q ξ kvarh
Q1 var	f Hz	PF1	f Hz	En S kVAh	En Q \oplus kvarh

7.6 Archiving mode

In the options, select the **Archiving** mode and confirm selection by pressing the button **Select**.



Fig. 20. Screens of Archiving mode

Table 7

Item		Parameter name	Range	Notes/description	Default settings
1	Group 1 Group 2	Archive type	n_on, noFF, on,oFF, H_on, HoFF, 3non, 3noF, 3_on, 3_oF	Archiving type - archiving on condition acc. to Fig. 21	n_on
2		Parameters	U1, I1, P1, ... T1, T2	Archived values (acc. to Table 8)	
3		Trigger	U1, I1, P1, ... T1, T2, hh:mm	Value triggering archiving	U1
4		Interval	0 .. 3600 s	Archiving period in seconds	0 s
5		Archive low	-144.0 .. +144.0	Archiving lower limit in % of the rated triggering value	0.0%
6		Archive high	-144.0 .. +144.0	Archiving upper limit in % of the rated triggering value	0.0%
7	CSV settings	Value separator	Comma, Semicolon, Tabulator	CSV files settings in files archive	Comma
8		Decimal separator	Dot, comma		Dot
9	Actions	Copy arch. to CSV	No, Yes	copying of internal memory to files archive	No
10		Clear archive	No, Yes		No

Entering a value "Archive high" lower than "Archive low" or equal switches the registration off. Not applicable for H_on mode.

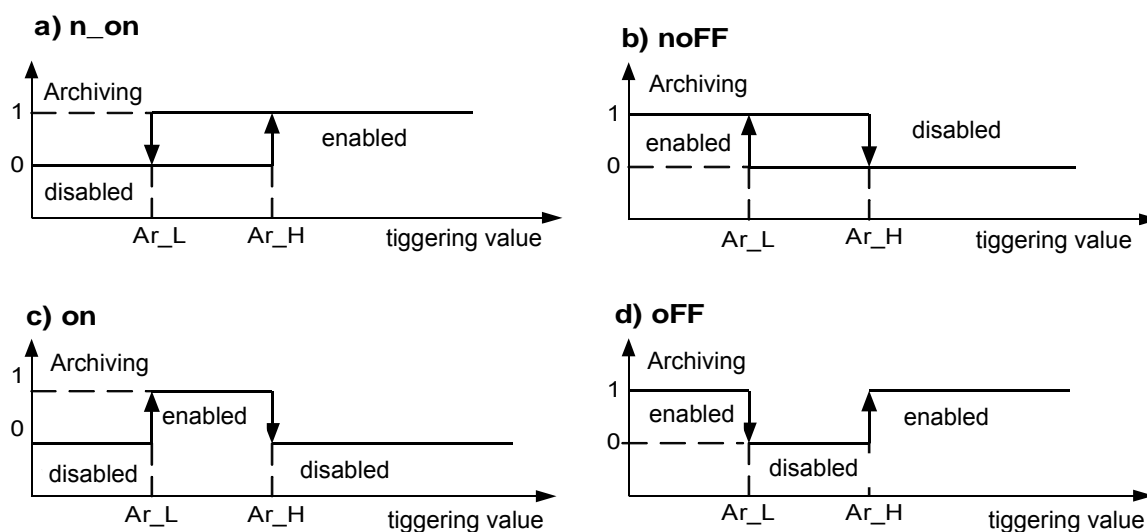

Fig.21. Archiving types: a) n_on b) noFF c) on d) OFF

Remaining types of the archiving:

- **H_on** – always enabled;
- **HoFF** – always disabled,
- **3non** – archiving is enabled when n_on type condition occurs on any phase. It will be switched off only when all triggering condition are disabled.
- **3noF** – archiving is enabled when noFF type condition occurs on any phase. It will be switched off only when all triggering condition are disabled.
- **3_on** – archiving is enabled when on type condition occurs on any phase. It will be switched off only when all triggering condition are disabled.
- **3_oF** – archiving is enabled when oFF type condition occurs on any phase. It will be switched off only when all triggering condition are disabled.
- The value triggering an archiving in the series 3 archiving must be in the range: 01-09 (acc. to Table 8). Archiving works with identical thresholds of the Ar_L and Ar_H hysteresis for each phase.

Selection of the values on the alarm outputs, analog and archived:

Table 8

Value in registers	Displayed element	Value type	Value of the needed for calculations of percentage corresponding to 100% of the rated range.
01	U1	L1 phase voltage	U_n [V] *
02	I1	L1 phase wire current	I_n [A] *
03	P1	L1 phase active power	$U_n \times I_n \times \cos(0^\circ)$ [W] *
04	Q1	L1 phase reactive power	$U_n \times I_n \times \sin(90^\circ)$ [Var] *
05	S1	L1 phase apparent power	$U_n \times I_n$ [VA] *
06	PF1	L1 phase power factor (PF)	1
07	tg1	tg factor φ of L1 phase	1
08	THD U1	L1 phase voltage THD**	100.00 [%]
09	THD I1	L1 phase current THD	100.00 [%]
10	U2	L2 phase voltage	U_n [V] *
11	I2	L2 phase wire current	I_n [A] *

12	P2	L2 phase active power	$U_n \times I_n \times \cos(0^\circ)$ [W] *
13	Q2	L2 phase reactive power	$U_n \times I_n \times \sin(90^\circ)$ [Var] *
14	S2	L2 phase apparent power	$U_n \times I_n$ [VA] *
15	PF2	L2 phase active power factor PF	1
16	tg2	tg ϕ factor of L2 phase	1
17	THD U2	L2 phase voltage THD**	100.00 [%]
18	THD I2	L2 phase current THD	100.00 [%]
19	U3	L3 phase voltage	U_n [V] *
20	I3	L3 phase wire current	I_n [A] *
21	P3	L3 phase active power	$U_n \times I_n \times \cos(0^\circ)$ [W] *
22	Q3	L3 phase reactive power	$U_n \times I_n \times \sin(90^\circ)$ [Var] *
23	S3	L3 phase apparent power	$U_n \times I_n$ [VA] *
24	PF3	L3 phase active power factor PF	1
25	tg3	tg ϕ factor of L3 phase	1
26	THD U3	L3 phase voltage THD**	100.00 [%]
27	THD I3	L3 phase current THD	100.00 [%]
28	U avg	mean phase voltage	0.00 [%]
29	I avg	mean 3-phase current	I_n [A] *
30	ΣP	3-phase active power (P1+P2+P3)	$3 \times U_n \times I_n \times \cos(0^\circ)$ [W] *
31	ΣQ	3-phase reactive power (Q1+Q2+Q3)	$3 \times U_n \times I_n \times \sin(90^\circ)$ [Var] *
32	ΣS	3-phase apparent power (S1+S2+S3)	$3 \times U_n \times I_n$ [VA] *
33	PF avg	3-phase power factor (PF)	1
34	tg avg	tg factor ϕ for 3 phases	1
35	THD U	3-phase voltage THD**	100.00 [%]
36	THD I	3-phase current THD	100.00 [%]
37	f	frequency	100 [Hz]
38	U12	phase-to-phase voltage L1-L2	$\sqrt{3} U_n$ [V] *
39	U23	phase-to-phase voltage L2-L3	$\sqrt{3} U_n$ [V] *
40	U31	phase-to-phase voltage L3-L1	$\sqrt{3} U_n$ [V] *
41	U123	mean phase-to-phase voltage	$\sqrt{3} U_n$ [V] *
42	P DMD	active power averaged (P Demand)*	$3 \times U_n \times I_n \times \cos(0^\circ)$ [W] *
43	S DMD	apparent power averaged (S Demand)*	$3 \times U_n \times I_n$ [VA] *
44	I DMD	current averaged (I Demand) *	I_n [A] *
45	I N	neutral wire current	I_n [A] *
46	T1	Temperature T1 of input 1	400 [°C]
47	T2	Temperature T2 of input 2	400 [°C]
48	En P+	Active 3-phase import energy	100,000 [kWh]
49	En P-	Active 3-phase export energy	100,000 [kWh]
50	En Q ξ	Reactive 3-phase inductive energy	100,000 [kvarh]
51	En Q \oplus	Reactive 3-phase capacity energy	100,000 [kvarh]
52	En S	3-phase apparent energy	100,000 [kVAh]
53	Phase sequence	Phase sequence	L1, L2, L3 - 0.00 [%] L1, L3, L2 - 100.00 [%]
54	hh:mm	time, hhx100+mm	2,400 - 100 [%]

* U_n , I_n - rated values of rated voltages and currents

** In the 3-phase 3-wire (3Ph / 3W) respectively THD U12, THD U23, THD U31 THD U123

To register in each group, you can select 16 of 53 parameters (bits 1 to 53 of the registers 4106...4109 and 4115...4118). Bit set to "1" adds a parameter to a registration, set to "0" deletes. It is possible to set all 53 bits but only the first 16 bits set to "1" will be taken for a registration.

7.7 Ethernet mode

In the options, select the **Ethernet** mode and confirm your choice by pressing the button **Select**

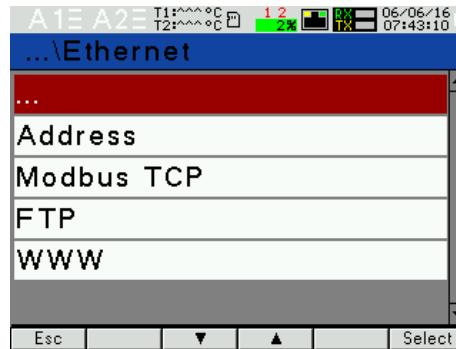

Fig.22. Screens of Ethernet mode

Table 9

Item		Parameter name	range	Notes/description	Manufacturer's value	
1	Addresses	DHCP	Off/On	Enabling / disabling the DHCP Client (supports automatic obtaining of IP protocol parameters of the meter's Ethernet interface from external DHCP servers in the same LAN)	Off	
2		Mode	Auto, 10 Mb/s, 100 Mb/s		Auto	
3		Address IP	0.0.0.0...255.255.255.255	10.0.1.161	Obtained from DHCP or entered manually when DHCP is disabled	-
4		Subnet Mask	0.0.0.0...255.255.255.255	255.0.0.1		-
5		Gateway	0.0.0.0...255.255.255.255	0.0.0.0		-
6		DNS address	0.0.0.0...255.255.255.255	10.0.0.44		-
7		MAC address		Aa:bb:cc:00:21:01	-	
8	Modbus TCP	Address	1 .. 247		1	
9		Port	80 ... 32,000		1	
10		Max. connection limit	1 ... 4		1	
11		Waiting	10 .. 360		60s	

		Time				
12	FTP	Command port	20 .. 32000		21	
13		Data port	20 .. 32000		1025	
14	WWW	Port	80 .. 32000		80	
15	MQTT	Connection state	Only readout	Conneccion state with MQTT server: (register value) 0xFFFF – Disconnected (register value) 0x0 – Connecting (register value) 0x1 – Connected	Disconnected	
16		IP address	0.0.0.0...255.255.255.255		37.187.106.16	
17		Port no	1 ... 65534		MQTT Broker port number	1883
18		Publish time	1 ... 3600		Period, what data are published (in seconds)	5
19		Client name			MQTT client name	ND30-MQTT-CLIENT
20		Topic Name			MQTT topic name	ND30-MEAS-TOPIC
21		MQTT On/Off	0,1		Enabling or disabling publishing data for the MQTT server: 0 - data are not published, 1 - publishing data to the server.	0
22		Save to FRAM	0,1		Save configuration to non-volatile memory: 0 - no changes, 1 - save changes.	0

7.8 Modbus mode

In the options, select the **Modbus** mode and confirm your choice by pressing the button **Select**.

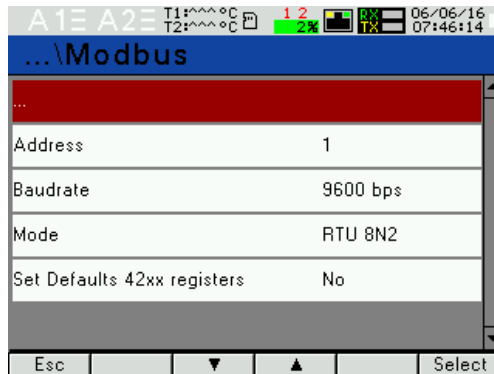

Fig.23. Screens of Modbus mode

Table 10

Item	Parameter name	Feature / value	Description	Manufacturer's value
1	Address	1...247	Modbus Network Address	1
2	Baud rate	4800 b/s, 9600 b/s, 19.2 kb/s, 38.4 kb/s, 57.7 kb/s, 115.2 kb/s	Baud rate	9600 b/s
3	Mode	RTU 8N2, RTU 8N1, RTU 8O1, RTU 8N1	Transmission mode	RTU 8N2
4	Set Defaults 42xx registers	No, Yes	Programmable group of registers for readout	No

7.9 Settings mode

In the options, select the **Settings** mode and confirm your choice by pressing the button **Select**.

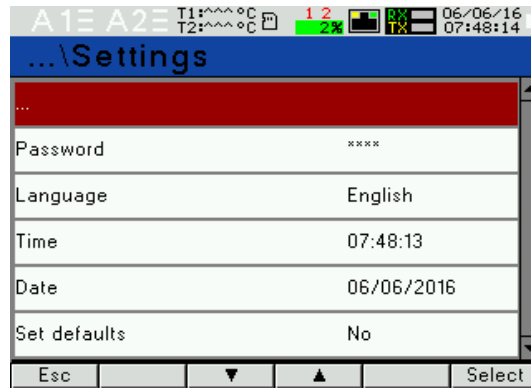

Fig.24. Screens of Settings mode

Table 11

Item	Parameter name	Feature / value	Description	Manufacturer's value
1	Password	0 .. 9999	0 - disabled	0
2	Language	English, Polski, Deutsch		Polish
3	Time	hh:mm	hour:minute	00:00:00
4	Date	dd/mm/yyyy	Day/month/year	1.01.2015
5	Set defaults	No, Yes		No

7.10 Information mode

In the options, select the **Information** mode and confirm your choice by pressing the button **Select**.

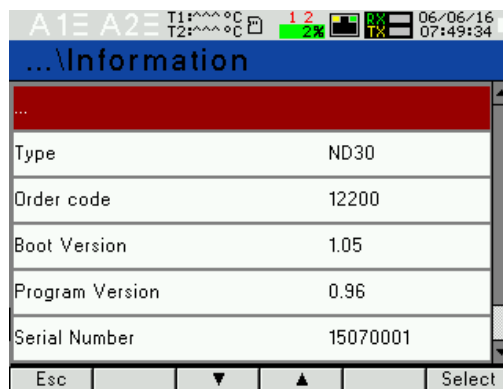

Fig.25. Screens of Information mode

Table 12

Item	Parameter name	Feature / value	Description	Manufacturer's value
1	Type		Meter type	ND30IoT
2	Order code		First 5 digits of the ordering code	e.g. 12200
3	Boot version		Bootloader version	e.g. 1.04
4	Program version		Main program version of the meter	e.g. 0.60
5	Serial number	ddmmxxxx	Current serial number of the meter day month current number	e.g. 15070006
6	MAC address	xx:xx:xx:xx:xx:xx	48-bit hardware address of Ethernet interface in hexadecimal format	e.g. 64:0E:0D:0C:0B:0A
7	DHCP	Off/On	Enabling/Disabling DHCP Client (service of automatic acquiring of the meter Ethernet IP protocol parameters from External DHCP Servers within the same Local Area Network)	Off
8	IP Address	0.0.0.0...255.255.255.255	10.0.1.161	Acquired from DHCP or entered manually when DHCP is deactivated
9	Subnet mask	0.0.0.0...255.255.255.255	255.0.0.1	
10	Default gateway	0.0.0.0...255.255.255.255	0.0.0.0	
11	DNS Address	0.0.0.0...255.255.255.255	10.0.0.44	
12	Service code	12A49AD32EF7C98A12BC	20-character code enabling extended functionality	

8 MEASURING VALUES ARCHIVING

8.1 INTERNAL MEMORY

The ND30IoT meters are equipped with 4MB of internal memory and 8GB memory for storing the recorded data. 4MB internal memory allows to register 40,960 records. The memory is a ring buffer type one.

8.2 COPYING ARCHIVE

If the 4MB internal memory is full at 70% or forced at any time: in **Archiving** mode, select **Actions** and set "Copy the archive to a CSV file" parameter to "Yes". The recorded data will be copied to the files archive. To start the procedure of copying archive can also be done via the RS485 interface (register 4125) or by simultaneously pressing the button **Max** and **Min**.

Example: files archive with archiving period of 5 seconds allows you to register data for 2 years. If the files archive is full at 70% - archive used in % will become orange (see: Status 3 Register – address 7561).

When the files archive is full (less than 14 days at 1 sec. interval to completely use a the files

archive space) the color will change to flashing red.

The ND30IoT meter creates the directories and the files the files archive while the internal memory is being copied. An example of the directory structure is shown in Figure 26.

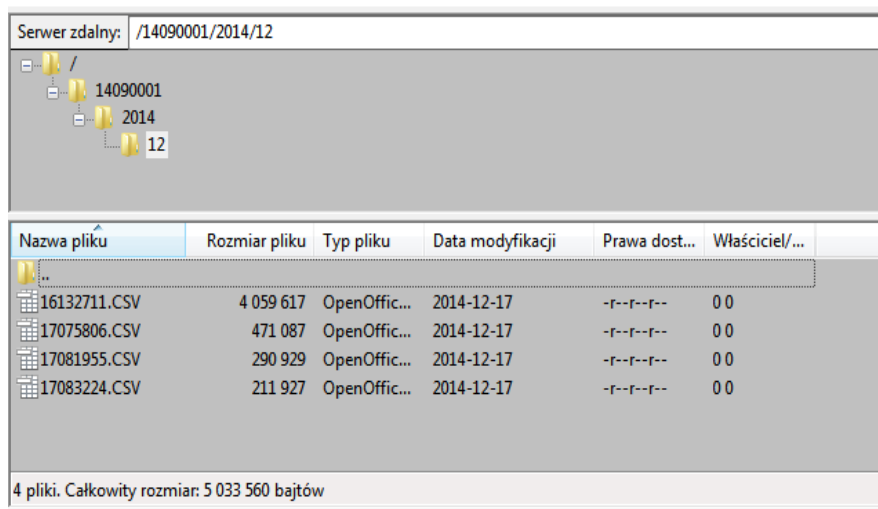

Fig.26. Directory structure in the files archive

Data in the files archive is stored in the files in the directories (year, month archive copy) - see Fig. 26. The file names are marked by day and time of the first record and have the ddhmmss.csv format, where: dd-day, hh-hour, mm-minute, ss-second.

8.3 ARCHIVE FILES STRUCTURE

The archived data files are in the form of the columns, where each column of data is separated by a comma. A column description is in the first line of the file. Data records are sequentially arranged in the rows. An example of the file is shown in Figure 27.

```

Plik  Edycja  Format  Widok  Pomoc
date,time,record index,block,register1,name1,value1, .. register16,name16,value16
2014-12-17,08:32:24,0000512808,0,7500, U_1,2.237693E+02, .. 7519, I_3,0.000000E+00
2014-12-17,08:32:25,0000512809,0,7500, U_1,2.237693E+02, .. 7519, I_3,0.000000E+00
2014-12-17,08:32:26,0000512810,0,7500, U_1,2.240464E+02, .. 7519, I_3,0.000000E+00
2014-12-17,08:32:27,0000512811,0,7500, U_1,2.241046E+02, .. 7519, I_3,0.000000E+00
2014-12-17,08:32:28,0000512812,0,7500, U_1,2.243908E+02, .. 7519, I_3,0.000000E+00
2014-12-17,08:32:29,0000512813,0,7500, U_1,2.240464E+02, .. 7519, I_3,0.000000E+00
2014-12-17,08:32:30,0000512814,0,7500, U_1,2.243908E+02, .. 7519, I_3,0.000000E+00
2014-12-17,08:32:31,0000512815,0,7500, U_1,2.241046E+02, .. 7519, I_3,0.000000E+00
2014-12-17,08:32:32,0000512816,0,7500, U_1,2.246347E+02, .. 7519, I_3,0.000000E+00
2014-12-17,08:32:33,0000512817,0,7500, U_1,2.246347E+02, .. 7519, I_3,0.000000E+00
2014-12-17,08:32:34,0000512818,0,7500, U_1,2.244283E+02, .. 7519, I_3,0.000000E+00
2014-12-17,08:32:35,0000512819,0,7500, U_1,2.244283E+02, .. 7519, I_3,0.000000E+00
2014-12-17,08:32:36,0000512820,0,7500, U_1,2.243908E+02, .. 7519, I_3,0.000000E+00
2014-12-17,08:32:37,0000512821,0,7500, U_1,2.246347E+02, .. 7519, I_3,0.000000E+00
2014-12-17,08:32:38,0000512822,0,7500, U_1,2.246347E+02, .. 7519, I_3,0.000000E+00
2014-12-17,08:32:39,0000512823,0,7500, U_1,2.246523E+02, .. 7519, I_3,0.000000E+00
2014-12-17,08:32:40,0000512824,0,7500, U_1,2.246523E+02, .. 7519, I_3,0.000000E+00
2014-12-17,08:32:41,0000512825,0,7500, U_1,2.244662E+02, .. 7519, I_3,0.000000E+00

```

Fig.27. An example of the archive data file

The fields in the line describing the record have the following meanings:

- date – date of data recording, date separator is the character "-"
- time – hour, minute, second of recorded data, a time separator is the character ":"
- record index – unique index record. Each record has a unique number. This number increases when writing new records.
- block – reserved
- register1 – Modbus register address of the first archived value
- name1 – Modbus register description of the first archived value

- value1 – first archived value. The decimal separator is ".", the values are saved in a engineering notation format.
- :
- register16 – Modbus register address of the sixteenth archived value
- name16 – Modbus register description of the sixteenth archived value
- value16 – sixteenth archived value. The decimal separator is ".", the values are saved in a engineering notation format.

name1, ...,name16 – description according to Table 8 (Displayed parameter).

8.4 DOWNLOADING ARCHIVE

Archived data can be downloaded via Ethernet using FTP protocol.

9 SERIAL INTERFACES

9.1 RS485 INTERFACE – list of parameters

The implemented protocol is compliant with the PI-MBUS-300 Rev G specification of Modicon. List of ND30IoT meter serial interface parameters:

- identifier 0xD9
- meter address 1..247,
- baud rate 4.8, 9.6, 19.2, 38.4, 57.6, 115.2 kbit/s
- operating mode Modbus RTU
- transmission mode 8N2, 8E1, 8O1, 8N1
- max. response time 600 ms
- max. no. of registers read in a single query
 - 61 – for 4-byte registers
 - 122 – for 2-byte registers
- implemented functions
 - 03, 04, 06, 16, 17
 - 03, 04 register readout
 - 06 single register writing
 - 16 writing of n-registers,
 - 17 device identification

Default settings: address 1, baud rate 9.6 kbit/s, mode RTU 8N2

9.2 Examples of registers' readout and write

Readout of n-registers (code 03h)

Example 1. Readout of two 16-bit integer registers, starting with the register address 0FA0h (4000) - register values 10, 100.

Request:

Device address	Function	Register address		Number of registers		CRC checksum
		B1	B0	B1	B0	
01	03	0F	A0	00	02	C7 3D

Response:

Device address	Function	Number of bytes	Value from the register 0FA0 (4000)		Value from the register 0FA1 (4001)		CRC checksum
			B1	B0	B1	B0	
01	03	04	00	0A	00	64	E4 6F

Example 2. Readout of two 32-bit float registers as a combination of two 16-bit registers, starting with the register address 1B58h (7000) - register values 10, 100.

Request:

Device address	Function	Register address		Number of registers		CRC checksum
		B1	B0	B1	B0	
01	03	1B	58	00	04	C3 3E

Response:

Device address	Function	Number of bytes	Value from the register 1B58 (7000)		Value from the register 1B59 (7001)		Value from the register 1B5A (7002)		Value from the register 1B5B (7003)		CRC checksum
			B3	B2	B1	B0	B3	B2	B1	B0	
01	03	08	41	20	00	00	42	C8	00	00	E4 6F

Example 3. Readout of two 32-bit float registers as a combination of two 16-bit registers, starting with the register address 1770h (6000) - register values 10, 100.

Request:

Device address	Function	Register address		Number of registers		CRC checksum
		B1	B0	B1	B0	
01	03	17	70	00	04	4066

Response:

Device address	Function	Number of bytes	Value from the register 1770h (6000)		Value from the register 1770h (6000)		Value from the register 1772h (6002)		Value from the register 1772h (6002)		CRC checksum
			B1	B0	B3	B2	B1	B0	B3	B2	
01	03	08	00	00	41	20	00	00	42	C8	E4 6F

Example 4. Readout of two 32-bit float registers, starting with the register address 1D4Ch (7500) - register values 10, 100.

Request:

Device address	Function	Register address		Number of registers		CRC checksum
		B1	B0	B1	B0	
01	03	1D	4C	00	02	03 B0

Response:

Device address	Function	Number of bytes	Value from the register 1D4C (7500)				Value from the register 1D4D (7501)				CRC checksum
			B3	B2	B1	B0	B3	B2	B1	B0	
01	03	08	41	20	00	00	42	C8	00	00	E4 6F

Single register writing (code 06h)

Example 5. Writing the value 543 (0x021F) to the register 4000 (0x0FA0)

Request:

Device address	Function	Register address		Register value		CRC checksum
		B1	B0	B1	B0	
01	06	0F	A0	02	1F	CA 54

Response:

Device address	Function	Register address		Register value		CRC checksum
		B1	B0	B1	B0	
01	06	0F	A0	02	1F	CA 54

Writing to n-registers (code 10h)

Example 6. Writing two registers starting with the register address 0FA3h (4003)

Writing the values 20, 2000.

Request:

Device address	Function	Address reg.Hi	Address reg.Lo	No. of registers Hi	No. of registers Lo	Number of bytes	Value for the register 0FA3 (4003)		Value for the register 0FA4 (4004)		CRC checksum
							B1	B0	B1	B0	
01	10	0F	A3	00	02	04	00	14	07	D0	BB 9A

9.3.1 Connecting 10/100-BASE-T interface

Connect the device to a TCP/IP network using the RJ45 socket located at the back / terminal side / of the meter to get access to the Ethernet services.

The meter's RJ45 socket LEDs description:

- yellow LED - illuminates when the meter is properly connected to the Ethernet 100 Base-T, does not illuminate when the meter is not connected to a network or is connected to a 10-Base-T.
- green LED - Tx/Rx, illuminates (irregularly illuminates) when the meter sends and receives data, illuminates continuously when no data is transmitted

It is recommended to use a twisted pair cable to connect the meter to the network:

- U/FTP – twisted pair cable with a separate foil for every pair
- F/FTP – twisted pair cable with separate foil for every pair and additional foil shielding for the cable
- S/FTP (former SFTP) – twisted pair cable with separate foil for every pair and additional mesh cable shielding
- SF/FTP (former S-STP) – twisted pair cable with separate foil for every pair and additional mesh and foil cable shielding

The twisted pair cable categories according to the European standard EN 50173 are minimum: Class D (category 5) - for high-speed local area networks, includes the applications using the frequency band up to 100 MHz. For Ethernet connection use the category 5 STP type twisted-pair cable (shielded) with RJ-45 connector, wiring colors (according to Table 11), compliant to the following standards:

- EIA/TIA 568A for both connectors in strike-through connection (i.e. between ND30IoT and hub or switch)
- EIA/TIA 568A for the first connector and EIA/TIA 568B for the second one in the cross-over connection (i.e. when connecting the ND30IoT meter to the computer).

Table 13

Wire no.	Signal	Wire color according to the standard	
		EIA/TIA 568A	EIA/TIA 568B
1	TX+	white-green	white-orange
2	TX-	green	orange
3	RX+	white-orange	white-green
4	EPWR+	blue	blue
5	EPWR+	white-blue	white-blue
6	RX-	orange	green
7	EPWR-	white-brown	white-brown
8	EPWR-	brown	brown

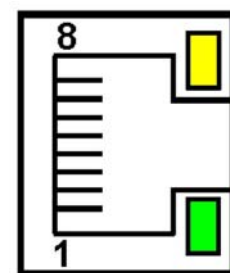

Fig. 28. View and pin numbering of the RJ45 socket

9.3.2 Web Server

The ND30IoT meter provides its own web server which enables remote monitoring of the measuring values and reading a status of the meter. A web page allows in particular to:

- obtain information about the device (serial number, code execution, software version, bootloader version, version (standard or special),
- preview current measuring values, read a device status,
- select the web page language

Access to the server can be achieved by entering the IP address of the meter in the web browser, for example: `http://192.168.1.030` (where 192.168.1.030 is set address of the meter). The default web server port is the port "80". The server port can be changed by the user.

Note: A browser with JavaScript enabled and compatible with XHTML 1.0 is required for correct operation of the website (all popular browsers, Internet Explorer version 8 minimum).

9.3.2.1 General view

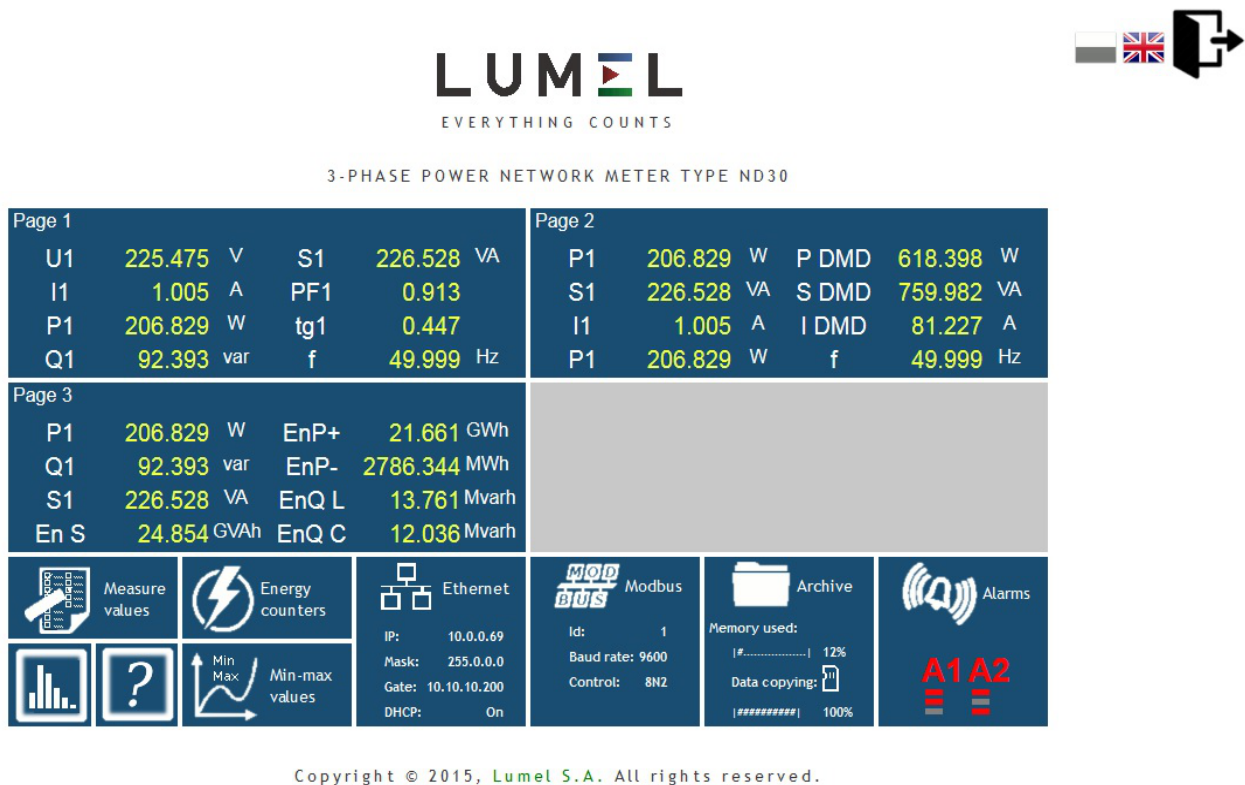

Fig. 29. View of the meter website

9.3.2.2 Web user selection

The meter has two user accounts for the web server protected by the individual passwords:

- user: "**admin**", password: "**admin**" - access to the configuration and preview of the parameters
- user: "**user**", password: "**pass**" - access only to the preview of the parameters.

Calling the IP address of the meeter in a browser, e.g. <http://192.168.1.30> will display a start website to enter a user name and a password.

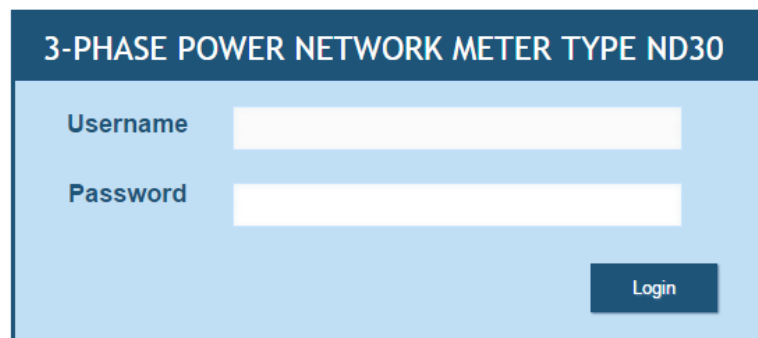

The image shows a web browser window with a light blue background. At the top, there is a dark blue header with the text "3-PHASE POWER NETWORK METER TYPE ND30" in white. Below the header, there are two white input fields. The first is labeled "Username" and the second is labeled "Password". To the right of the "Password" field, there is a dark blue button with the text "Login" in white.

Fig. 30. View of the meter's web server login window

Web server user name can not be changed. You can change the password for each user - for safety reasons it is recommended to change the passwords. Changing the password is possible only through a web page in the "Ethernet" parameter group. The passwords can be up to 8 characters. If the password is lost (what disables using the web server), restore the default settings of the Ethernet interface e.g. from the menu: Settings → Default settings → Yes or entering the value "1" to the register 4152. All standard meter parameters and Ethernet interface parameters (see Table 9) and the passwords of the web server users will be restored:

user "**admin**" → password: "**admin**";

user "**user**" → password "**pass**".

9.3.3 FTP Server

The FTP file sharing protocol has been implemented in the ND30IoT meters. The meter acts as a server, allowing the users to access the internal memory of its file system. Access to the files is possible using a computer, a tablet with installed FTP client or other device acting as a FTP client. The standard FTP ports are used for transferring files, "1025" - data port and "21" --

commands port. A user can change the port used by the FTP protocol if necessary. Please note, that the port configuration of the FTP server and the client must be the same.

The FTP client program can work in a passive mode. The connection is fully made by the FTP client in the passive mode (a client chooses the data port). It is possible to use up to one connection at the same time for the file transfer with the meter, so you should limit the maximum number of a FTP client connections to 1.

9.3.3.1 FTP user selection

The meter has two user accounts for the FTP server protected by the individual passwords:

- user: "**admin**", password: "**admin**" - access to read and write the files
- user: "**user**", password: "**passftp**" - access to read only the archive files.

The FTP user names can not be changed but you can change the password for each user - for safety reasons it is recommended to change the passwords. Changing the password is possible only through a web page in the "Ethernet" parameter group. The passwords can be up to 8 characters. If the password is lost (what disables using the FTP server), restore the default settings of the Ethernet interface e.g. from the menu: Settings → Default settings → Yes or entering the value "1" to the register 4152. All standard meter parameters and Ethernet interface parameters (see Table 9) and the passwords of the FTP server users will be restored:

user "**admin**" → password: "**admin**";

user "**user**" → password "**passftp**".

The program FileZilla could be an example of the FTP client. You can view and download the archive files by entering the IP address of the meter in the address field.

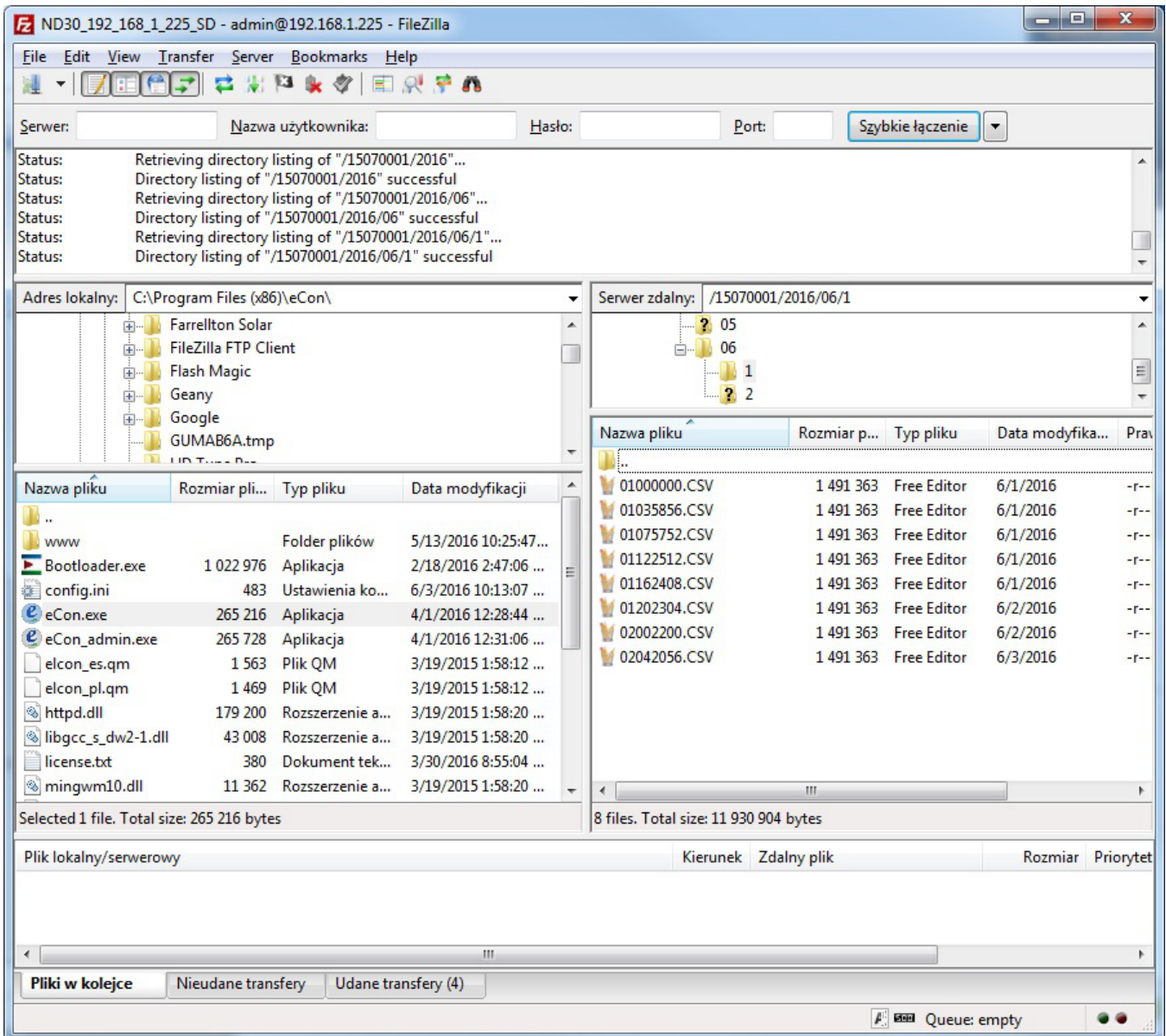

Fig. 31. View of the FTP session in the program FileZilla

9.3.4 Modbus TCP/IP

The ND30IoT meter allows access to the internal registers via the Ethernet interface and Modbus TCP/IP protocol. It is necessary to set the unique IP address of the meter and set the connection parameters listed in Table 14 to set up a connection.

Table 14

Register	Description	Default value
4146	Device address for Modbus TCP/IP protocol	1
4147	Modbus TCP port number	502
4145	Port closing time of Modbus TCP/IP service [s]	60
4144	The maximum simultaneous connections to Modbus TCP/IP service	4

The device address is the address of the device for Modbus TCP/IP protocol and is not a value equal to a address value for Modbus RS485 protocol (Modbus network address register 4100). Setting the parameter "Device address for Modbus TCP/IP protocol" of the meter to the value "255", the meter will skip the address analysis in the frame of Modbus protocol (broadcast mode).

9.3.5 MQTT protocol

MQTT is an uncomplicated protocol used in the Internet of Things (IoT). It is based on a publication/subscription pattern. ND30IoT, using this protocol, publishes various important control and measurement information on an external server. If the server is located in the Internet network, it is possible to read the parameters of the ND30IoT meter from any place in the world with an access to this network.

The MQTT protocol is configured in ND30IoT from the menu level (chapter 7.7 of the ND30IoT meter user's manual) or by using the Modbus RTU protocol via the RS-485 interface and Modbus TCP via the Ethernet interface. The parameters to be set are the IP address and the broker port, that is the MQTT server receiving the publications from the ND30IoT meter. The period between consecutive publications can be set in the limit (1-3600) s. Data are sent to the server in the form of text (ASCII). It is not required that the data be formatted in any special way. Nevertheless, ND30IoT uses the JSON format to send variable names and their associated values. The format of data sent by ND30IoT is as follows:

```
{"meter":"Unique ID","slot":"Date Time+TimeZone","ParameterIndex":"Value",...}
```

where:

Unique ID - is the name of the MQTT client entered in the ND30IoT meter,

Date Time - is the current date and time separated by a space,

Time Zone - is the time zone for Poland, that is +1:00,

Parameter Index - is a number that specifies the quantity measured according to the table below,

Value - is the number corresponding to the value of the measured quantity.

The number of parameters sent and the corresponding values is always the same and equal to 36, that is the number of quantities presented in the table below.

Parameter Index	Basic measurement	Unit of the quantity	Quantity	Parameter description
1	Voltage	V	Volts	Phase 1 voltage
2	Voltage	V	Volts	Phase 2 voltage
3	Voltage	V	Volts	Phase 3 voltage
4	Current	A	Amperes	Phase 1 current
5	Current	A	Amperes	Phase 2 current
6	Current	A	Amperes	Phase 3 current
7	Active power	kW	Kilowatts	Active power of phase 1
8	Active power	kW	Kilowatts	Active power of phase 2
9	Active power	kW	Kilowatts	Active power of phase 3
10	Apparent power	kVA	Kilo-Volt-Amperes	Apparent power of phase 1
11	Apparent power	kVA	Kilo-Volt-Amperes	Apparent power of phase 2
12	Apparent power	kVA	Kilo-Volt-Amperes	Apparent power of phase 3
13	Reactive power	kVAR	Kilovars	Reactive power of phase 1
14	Reactive power	kVAR	Kilovars	Reactive power of phase 2
15	Reactive power	kVAR	Kilovars	Reactive power of phase 3
16	Power factor	none	none	Power factor of phase 1
17	Power factor	none	none	Power factor of phase 2
18	Power factor	none	none	Power factor of phase 3
19	Phase angle	°	Angular degrees	Phase angle of phase 1
20	Phase angle	°	Angular degrees	Phase angle of phase 2
21	Phase angle	°	Angular degrees	Phase angle of phase 3
22	Voltage	V	Volts	The average of three phase voltages
23	Voltage	V	Volts	The sum of three phase voltages
24	Current	A	Amperes	The average of three phase currents
25	Current	A	Amperes	The sum of three phase currents
26	Active power	kW	Kilowatts	The average of three active powers
27	Active power	kW	Kilowatts	The sum of three active powers
28	Apparent power	kVA	Kilo-Volt-Amperes	The average of three apparent powers
29	Apparent power	kVA	Kilo-Volt-Amperes	The sum of three apparent powers
30	Reactive power	kVAR	Kilo-Volt-Amperes	The average of three reactive powers

31	Reactive power	kVAR	Kilo-Volt-Amperes	The sum of three reactive powers
32	Power factor	none	none	The average of three power factors
33	Power factor	none	none	The sum of three power factors
34	Phase angle	°	Deg	The average of three phase angles
35	Phase angle	°	Deg	The sum of three phase angles
36	Periods per second	Hz	Hz	Network frequency

10 MAP OF ND30IoT METER REGISTERS

In the ND30IoT meter, data are placed in 16 and 32-bit registers. Process variables and meter parameters are placed in the address area of registers in a way depended on the variable value type. Bits in 16-bit register are numbered from the youngest to the oldest (b0-b15). The 32-bit registers contain numbers of float type in IEEE-754 standard. 3210 byte sequence - the oldest is sent first.

Table 15

Address range	Value type	Description
4000 – 4159	Integer (16 bits)	Value set in the 16-bit register. Registers for meter configuration. Description of registers is shown in Table 16. Registers for writing and readout.
4200 – 4260	Integer (16 bits)	Value set in the 16-bit register. Registers for configuration of programmable group of registers for readout. Description of registers is shown in Table 15. Registers for writing and readout.
4300 - 4388	Integer (16 bits)	Value set in the 16-bit register. Registers for displayed pages configuration. Description of registers is shown in Table 19. Registers for writing and readout.
4400- 4440	Integer (16 bits)	Value set in the 16-bit register. Status registers, energy value, MAC address of the meter, configuration data. Description of registers is shown in Table 20. Readout registers.
4500-4529	Integer (16 bits)	Value placed in one 16-bit register. Configuration registers of the MQTT protocol.
6000 – 6922	Float (2x16 bits)	Value is set in the two following 16-bit registers. Registers contain exactly the same data, as 32-bit registers of 7500 – 7953 range. Readout registers. Bytes sequence (1-0-3-2)
7000 - 7118	Float (2x16 bits)	Content of the registers set in the registers 4200 – 4359. Bytes sequence (3-2-1-0)
7200 – 7318	Float (2x16 bits)	Content of the registers set in the registers 4200 – 4359. Bytes sequence (1-0-3-2)
7400 - 7459	Float (32 bits)	Content of the registers set in the registers 4200 – 4359. Values set in one 32-bit register.
7500 – 7961	Float (32 bits)	Values set in one 32-bit register. Description of registers is shown in Table 21. Readout registers.
8000 - 8922	Float (2x16 bits)	Value is set in the two following 16-bit registers. Registers contain exactly the same data, as 32-bit registers of 7500 – 7953 range. Readout registers. Bytes sequence (3-2-1-0)

Table 16

Register address	Operations	Range	Description	Default
4000	RW	0...9999	Protection - password	0
4001	RW	0 .. 1	Type of connection 0 - 3Ph/4W 1 - 3Ph/3W 2 - 1Ph/2W	0
4002	RW	0 .. 2	Voltage on terminal 2 0 - first L1 phase voltage 1 - second L2 phase voltage 2 - third L3 phase voltage	0
4003	RW	0 .. 2	Voltage on terminal 5 0 - first L1 phase voltage 1 - second L2 phase voltage 2 - third L3 phase voltage	1
4004	RW	0 .. 2	Voltage on terminal 8 0 - first L1 phase voltage 1 - second L2 phase voltage 2 - third L3 phase voltage	2
4005	RW	0..5	Current on terminals 1, 3: 0 - first phase I_{L1} current 1 - reversed direction of the current of phase L1: $-I_{L1}$ 2 - second phase I_{L2} current 3 - reversed direction of the current of phase L2: $-I_{L2}$ 4 - third phase I_{L3} current 5 - reversed direction of the current of phase L3: $-I_{L3}$	0
4006	RW	0..5	Current on terminals 4, 6: 0 - first phase I_{L1} current 1 - reversed direction of the current of phase L1: $-I_{L1}$ 2 - second phase I_{L2} current 3 - reversed direction of the current of phase L2: $-I_{L2}$ 4 - third phase I_{L3} current 5 - reversed direction of the current of phase L3: $-I_{L3}$	2
4007	RW	0..5	Current on terminals 7, 9: 0 - first phase I_{L1} current 1 - reversed direction of the current of phase L1: $-I_{L1}$ 2 - second phase I_{L2} current 3 - reversed direction of the current of phase L2: $-I_{L2}$ 4 - third phase I_{L3} current 5 - reversed direction of the current of phase L3: $-I_{L3}$	4
4008	RW	0,1	Input current range: 1 A or 5 A: 0 - 1 A, 1 - 5 A	1
4009	RW	0,1	Input voltage range: 0 - 3 x 57.7/100 V; 1 - 3 x 230/400 V (version 1) 0 - 3 x 110/190 V; 1 - 3 x 400/690 V (version 2)	1
4010	RW	0..18	Transformer primary voltage, two older bytes	0
4011	RW	0..65535	Transformer primary voltage, two younger bytes	100
4012	RW	1 .. 10000	Transformer secondary voltage x 10	1000
4013	RW	1 .. 20000	Transformer primary current	5
4014	RW	1 .. 1000	Transformer secondary current	5
4015	RW	0...2	Averaging time of the active power P Demand apparent power S Demand current I Demand 0 - 15, 1- 30, 2- 60 minutes	0
4016	RW	0.1	Synchronization with real-time clock 0 - no synchronization 1 - synchronization with a clock	1
4017	RW		reserved	
4018	RW		reserved	
4019	RW		reserved	

4020	RW		Resistance of wires for the input T1 x 100	0
4021	RW		Resistance of wires for the input T2 x 100	0
4022	RW		reserved	
4023	RW		reserved	
4024	RW	0...4	Energy counters erasing 0 – no changes, 1 – erase active energies 2 – erase reactive energies, 3 – erase apparent energies, 4 – erase all energies	0
4025	RW	0.1	Erasing averaged parameters P Demand, S Demand, I Demand	0
4026	RW	0.1	Min, max erasing	0
4027	RW	0.1	Erasing alarm signalization latch	0
4028	RW		reserved	
4029	RW		reserved	
4030	RW	0...4	Alarm output 1 - Logic tasks of the conditions 1, 2, 3 0 – C1 1 – C1 v C2 v C3 2 – C1 ^ C2 ^ C3 3 – (C1 ^ C2) v C3 4 – (C1 v C2 ^ C3	0
4031	RW	0,1	Alarm output 1 - State of the relay at the alarm switched on: 0 - relay disabled 1 - relay enabled	1
4032	RW	0,1	Alarm output 1 - alarm deactivation lock	0
4033	RW	0,1	Alarm output 1 - alarm signalization	0
4034	RW	0.1..43	Alarm output 1 - value for the condition 1 (c1) (code as in Table 8)	38
4035	RW	0..9	Alarm output 1 - type for the condition 1: 0 – n_on, 1 – noFF, 2 – on, 3 – oFF, 4 – H_on, 5 – HoFF, 6 – 3non, 7 – 3noF, 8 – 3_on, 9 – 3_oF	0
4036	RW	-1440..0..1440 [%oo]	Alarm output 1 - lower value of the condition 1 switch of the rated input range	900
4037	RW	-1440..0..1440 [%oo]	Alarm output 1 - upper value of the condition 1 switch of the rated input range	1100
4038	RW	0..3600 s	Alarm output 1 - condition 1 activation delay	0
4039	RW	0..3600 s	Alarm output 1 - condition 1 deactivation delay	0
4040	RW	0..3600 s	Alarm output 1 - condition 1 re-activation lock	0
4041	RW	0,1	Alarm output 1 - condition 1 signalization	0
4042	RW		reserved	
4043	RW	0.1..43	Alarm output 1 - value for the condition 2 (c2) (code as in Table 8)	38
4044	RW	0..9	Alarm output 1 - type for the condition 2: 0 – n_on, 1 – noFF, 2 – on, 3 – oFF, 4 – H_on, 5 – HoFF, 6 – 3non, 7 – 3noF, 8 – 3_on, 9 – 3_oF	0
4045	RW	-1440..0..1440 [%oo]	Alarm output 1 - lower value of the condition 2 switch of the rated input range	900
4046	RW	-1440..0..1440 [%oo]	Alarm output 1 - upper value of the condition 2 switch of the rated input range	1100
4047	RW	0..3600 s	Alarm output 1 - condition 2 activation delay	0
4048	RW	0..3600 s	Alarm output 1 - condition 2 deactivation delay	0
4049	RW	0..3600 s	Alarm output 1 - condition 2 re-activation lock	0
4050	RW	0,1	Alarm output 1 – condition 2 signalization	0
4051	RW		reserved	
4052	RW	0.1..43	Alarm output 1 - value for the condition 3 (c3) (code as in Table 8)	38

4053	RW	0..9	Alarm output 1 - type for the condition 3: 0 – n_on, 1 – noFF, 2– on, 3 – oFF, 4 – H_on, 5 – HoFF, 6 – 3non, 7 – 3noF, 8 – 3_on, 9– 3_oF	0
4054	RW	-1440..0..1440 [%oo]	Alarm output 1 - lower value of the condition 3 switch of the rated input range	900
4055	RW	-1440..0..1440 [%oo]	Alarm output 1 - upper value of the condition 3 switch of the rated input range	1100
4056	RW	0..3600 s	Alarm output 1 - condition 3 activation delay	0
4057	RW	0..3600 s	Alarm output 1 - condition 3 deactivation delay	0
4058	RW	0..3600 s	Alarm output 1 - condition 2 re-activation lock	0
4059	RW	0,1	Alarm output 1– condition 2 signalization	0
4060	RW		reserved	
4061	RW	0...4	Alarm output 2 - Logic tasks of the conditions 1, 2, 3 0 – C1 1 – C1 v C2 v C3 2 – C1 ^ C2 ^ C3 3 – (C1 ^ C2) v C3 4 – (C1 v C2 ^ C3	0
4062	RW	0,1	Alarm output 2 - State of the relay at the alarm switched on: 0 - relay disabled 1 - relay enabled	1
4063	RW	0,1	Alarm output 2 - alarm deactivation lock	0
4064	RW	0,1	Alarm output 2 - alarm signalization	0
4065	RW	0.1..54	Alarm output 2 - value for the condition 1 (c1) (code as in Table 8)	38
4066	RW	0..9	Alarm output 2 - type for the condition 1: 0 – n_on, 1 – noFF, 2 – on, 3 – oFF, 4 – H_on, 5 – HoFF, 6 – 3non, 7 – 3noF, 8 – 3_on, 9 – 3_oF	0
4067	RW	-1440..0..1440 [%oo]	Alarm output 2 - lower value of the condition 1 switch of the rated input range	900
4068	RW	-1440..0..1440 [%oo]	Alarm output 2 - upper value of the condition 1 switch of the rated input range	1100
4069	RW	0..3600 s	Alarm output 2 - condition 1 activation delay	0
4070	RW	0..3600 s	Alarm output 2 - condition 1 deactivation delay	0
4071	RW	0..3600 s	Alarm output 2 - condition 1 re-activation lock	0
4072	RW	0,1	Alarm output 2– condition 1 signalization	0
4073	RW		reserved	
4074	RW	0.1..54	Alarm output 2 - value for the condition 2 (c2) (code as in Table 8)	38
4075	RW	0..9	Alarm output 2 - type for the condition 2: 0 – n_on, 1 – noFF, 2 – on, 3 – oFF, 4 – H_on, 5 – HoFF, 6 – 3non, 7 – 3noF, 8 – 3_on, 9 – 3_oF	0
4076	RW	-1440..0..1440 [%oo]	Alarm output 2 - lower value of the condition 2 switch of the rated input range	900
4077	RW	-1440..0..1440 [%oo]	Alarm output 2 - upper value of the condition 2 switch of the rated input range	1100
4078	RW	0..3600 s	Alarm output 2 - condition 2 activation delay	0
4079	RW	0..3600 s	Alarm output 2 - condition 2 deactivation delay	0
4080	RW	0..3600 s	Alarm output 2 - condition 2 re-activation lock	0
4081	RW	0,1	Alarm output 2– condition 2 signalization	0
4082	RW		reserved	
4083	RW	0.1..54	Alarm output 2 - value for the condition 3 (c3) (code as in Table 8)	38
4084	RW	0..9	Alarm output 2 - type for the condition 3: 0 – n_on, 1 – noFF,	0

			2 – on, 3 – oFF, 4 – H_on, 5 – HoFF, 6 – 3non, 7 – 3noF, 8 – 3_on, 9 – 3_oF	
4085	RW	-1440..0..1440 [%oo]	Alarm output 2 - lower value of the condition 3 switch of the rated input range	900
4086	RW	-1440..0..1440 [%oo]	Alarm output 2 - upper value of the condition 3 switch of the rated input range	1100
4087	RW	0..3600 s	Alarm output 2 - condition 3 activation delay	0
4088	RW	0..3600 s	Alarm output 2 - condition 3 deactivation delay	0
4089	RW	0..3600 s	Alarm output 2 - condition 2 re-activation lock	0
4090	RW	0,1	Alarm output 2 - condition 2 signalization	0
4091	RW		reserved	
4092	RW	0.1..54	Continuous output 1 - output value /code as in Tab. 8/	38
4093	RW	0..1	Continuous output 1 - type: 0 – (0...20) mA; 1 – (4...20) mA;	0
4094	RW	-1440..0..1440 [%oo]	Continuous output 1 - lower value of the input range in [%oo] of the rated input range	0
4095	RW	-1440..0..1440 [%oo]	Continuous output 1 - upper value of the input range in [%oo] of the rated input range	1000
4096	RW	-2400..0..2400	Continuous output 1 - lower value of the current output range (1 = 10 uA)	0
4097	RW	1..2400	Continuous output 1 - upper value of the current output range (1 = 10uA)	2000
4098	RW	0..2	Continuous output 1 - manual switching on 0 – normal work, 1 – value set from the register 4096, 2 – value set from the register 4097	0
4099	RW		reserved	
4100	RW	1..247	Modbus Network Address	1
4101	RW	0..3	Transmission mode: 0->8n2, 1->8e1, 2->8o1, 3->8n1	0
4102	RW	0..5	Baud rate: 0->4800, 1->9600 2->19200, 3->38400, 4->57600, 5->115200	1
4103	RW		reserved	
4104	RW	0.1	Upgrade change of transmission parameters	0
4105	RW		reserved	
4106	RW	0...0xFFFF	Group 1, archived values bit0 – reserved, bit1- U_1, bit2- I_1, ... , bit15- PF2, acc. to Table 8	0x0000
4107	RW	0...0xFFFF	Group 1, archived values bit16 – tg2, bit17-THDU2, ... , bit31– ΣQ, acc. to Table 8	0x0000
4108	RW	0...0xFFFF	Group 1, archived values bit32- ΣS, bit33- PF avg, ... , bit43 – T2, acc. to Table 8	0x0000
4109	RW	0...0x003F	Group 1, archived values bit48 EnP+,...,bit53-Phase sequence acc. to Table 8	0x0000
4110	RW	1...54	Group 1, value triggering archiving	1
4111	RW	0..9	Group 1, archiving type 0 – n_on, 1 – noFF, 2 – on, 3 – oFF, 4 – H_on, 5 – HoFF, 6 – 3non, 7 – 3noF, 8 – 3_on, 9 – 3_oF	0
4112	RW	-1440..0..1440	Group 1, archiving lower limit w %oo	900
4113	RW	-1440..0..1440	Group 1, archiving upper limit w %oo	1100
4114	RW	1 .. 3600	Group 1, archiving period in seconds	1
4115	RW	0...0xFFFF	Group 2, archived values bit0 – reserved, bit1- U_1, bit2- I_1, ... , bit15- PF2, acc. to Table 8	0x0000
4116	RW	0...0xFFFF	Group 2, archived values bit16 – tg2, bit17-THDU2, ... , bit31– ΣQ, acc. to Table 8	0x0000
4117	RW	0...0xFFFF	Group 2, archived values bit32- ΣS, bit33- PF avg, ... , bit43 – T2, acc. to Table 8	0x0000
4118	RW	0...0x003F	Group 2, archived values bit48 EnP+,...,bit53-Phase	0x0000

			sequence acc. to Table 8	
4119	RW	1...54	Group 2, value triggering archiving	1
4120	RW	0..9	Group 2, archiving type 0 – n_on, 1 – noFF, 2 – on, 3 – oFF, 4 – H_on, 5 – HoFF, 6 – 3non, 7 – 3noF, 8 – 3_on, 9 – 3_oF	0
4121	RW	-1440..0..1440	Group 2, archiving lower limit w ‰	900
4122	RW	-1440..0..1440	Group 2, archiving upper limit w ‰	1100
4123	RW	1 .. 3600	Group 2, archiving period in seconds	1
4124	RW		reserved	
4125	RW	0,1	Copying archive to files archive memory. "1" – copy archive to files archive memory / only the records which have been registered since the last copy /	0
4126	RW	0,1	Deleting the entire internal archive	0
4127	RW	0 .. 2	Field separator: 0 - comma , 1 - semicolon ; 2 - tab ''	,
4128	RW	0,1	Decimal separator 0 - dot '.' 1 - comma ','	.
4129	RW		reserved	
4130	RW		reserved	
4131	RW	0...65535	The third and the second byte (B3.B2) of the IP address of the meter, the IPv4 address format: B3.B2.B1.B0	49320 (0xC0A8 = 192.168)
4132	RW	0...65535	The first and zero byte (B1.B0) of the IP address of the meter, the IPv4 address format: B3.B2.B1.B0	356 (0x0164 = 1.100)
4133	RW	0...65535	The third and the second byte (B3.B2) of the subnet mask of the meter, the mask format: B3.B2.B1.B0	65535
4134	RW	0...65535	The first and zero byte (B1.B0) of the subnet mask of the meter, the mask format: B3.B2.B1.B0	65280
4135	RW	0...65535	The third and the second byte (B3.B2) of the default gateway of the meter, the gateway address format: B3.B2.B1.B0	49320
4136	RW	0...65535	The first and zero byte (B1.B0) of the default gateway of the meter, the gateway address format: B3.B2.B1.B0	257
4137	RW	0...65535	The third and the second byte (B3.B2) of the DNS address of the meter, the IPv4 address format: B3.B2.B1.B0	0x0808=8. 8
4138	RW	0...65535	The first and zero byte (B1.B0) of the DNS address of the meter, the IPv4 address format: B3.B2.B1.B0	0x0808=8. 8
4139	RW		reserved	
4140	RW	0,1	Enabling / disabling the DHCP Client (supports automatic obtaining of IP protocol parameters of the meter's Ethernet interface from external DHCP servers in the same LAN) 0 - DHCP disabled - you should manually configure the IP address and subnet mask of the meter; 1 - DHCP enabled, the meter will automatically receive the IP address, subnet mask, and gateway address from the DHCP server when switching the supply on or selecting APPL option from the menu or entering the value "1" to the register 4099. The gateway address is the address of the server that assigned the parameters to the meter;	1
4141	RW	0 .. 2	Baud rate of the Ethernet interface: 0 – automatic selection of the baud rate 1 – 10 Mb/s 2 – 100 Mb/s	0
4142	RW	20...65535	FTP server commands port number	21
4143	RW	20...65535	FTP server data port number	1025
4144	RW	1...4	The maximum simultaneous connections to Modbus TCP/IP service	1
4145	RW	10...600	Port closing time of Modbus TCP/IP service, in seconds	60

4146	RW	0...255	Device address for Modbus TCP/IP protocol	1
4147	RW	0...65535	Modbus TCP port number	502
4148	RW	80...65535	Web server port number	80
4149	RW	0,1	Saving the new parameters and initiate Ethernet interface 0 – no changes 1 - saving the new parameters and initiate the Ethernet interface	0
4150	RW	0..2	Menu language: 0-ENG, 1-PL, 2-DE	1
4151	RW	0,1	reserved	0
4152	RW	0.1	Saving default parameters (complete with resetting energy as well as min, max and mean power to 0) and Ethernet,	0
4153	RW	0..59	Seconds	0
4154	RW	0...2359	Hour *100 + minutes	0
4155	RW	101...1231	Month * 100 + day	101
4156	RW	2015...2077	Year	2015
4157	RW		reserved	
4158	RW		reserved	
4159	RW		reserved	

The alarm switching values stored in the registers 4036, 4037, 4054, 4055, 4067, 4068, 4076, 4077, 4085, 4086 are multiplied by 10, e.g. the value of 100% should be entered as "1000".

The lower and upper values of the input range of the continuous output stored in the registers 4094, 4095 are multiplied by 10, e.g. the value of 100% should be entered as "1000".

The lower and upper values of the current output range stored in the registers 4096, 4097 are multiplied by 100, e.g. the value of 20 mA should be entered as "2000".

Table 17

Register address	Operations	Range	Description	Default
4200	RW	7500 .. 7957	Register 1 of programmable group of registers for readout	7500
4201	RW	7500 .. 7957	Register 2 of programmable group of registers for readout	7501
4202	RW	7500 .. 7957	Register 3 of programmable group of registers for readout	7502
4203	RW	7500 .. 7957	Register 4 of programmable group of registers for readout	7503
4204	RW	7500 .. 7957	Register 5 of programmable group of registers for readout	7504
4205	RW	7500 .. 7957	Register 6 of programmable group of registers for readout	7505
4206	RW	7500 .. 7957	Register 7 of programmable group of registers for readout	7506
4207	RW	7500 .. 7957	Register 8 of programmable group of registers for readout	7507
4208	RW	7500 .. 7957	Register 9 of programmable group of registers for readout	7508
4209	RW	7500 .. 7957	Register 10 of programmable group of registers for readout	7509
4210	RW	7500 .. 7957	Register 11 of programmable group of registers for readout	7510
4211	RW	7500 .. 7957	Register 12 of programmable group of registers for readout	7511
4212	RW	7500 .. 7957	Register 13 of programmable group of registers for readout	7512
4213	RW	7500 .. 7957	Register 14 of programmable group of registers for readout	7513
4214	RW	7500 .. 7957	Register 15 of programmable group of registers for readout	7514
4215	RW	7500 .. 7957	Register 16 of programmable group of registers for readout	7515
4216	RW	7500 .. 7957	Register 17 of programmable group of registers for readout	7516
4217	RW	7500 .. 7957	Register 18 of programmable group of registers for readout	7517
4218	RW	7500 .. 7957	Register 19 of programmable group of registers for readout	7518
4219	RW	7500 .. 7957	Register 20 of programmable group of registers for readout	7519
4220	RW	7500 .. 7957	Register 21 of programmable group of registers for readout	7520
4221	RW	7500 .. 7957	Register 22 of programmable group of registers for readout	7521
4222	RW	7500 .. 7957	Register 23 of programmable group of registers for readout	7522
4223	RW	7500 .. 7957	Register 24 of programmable group of registers for readout	7523
4224	RW	7500 .. 7957	Register 25 of programmable group of registers for readout	7524

Register address	Operations	Range	Description	Default
4225	RW	7500 .. 7957	Register 26 of programmable group of registers for readout	7525
4226	RW	7500 .. 7957	Register 27 of programmable group of registers for readout	7526
4227	RW	7500 .. 7957	Register 28 of programmable group of registers for readout	7527
4228	RW	7500 .. 7957	Register 29 of programmable group of registers for readout	7528
4229	RW	7500 .. 7957	Register 30 of programmable group of registers for readout	7529
4230	RW	7500 .. 7957	Register 31 of programmable group of registers for readout	7530
4231	RW	7500 .. 7957	Register 32 of programmable group of registers for readout	7531
4232	RW	7500 .. 7957	Register 33 of programmable group of registers for readout	7532
4233	RW	7500 .. 7957	Register 34 of programmable group of registers for readout	7533
4234	RW	7500 .. 7957	Register 35 of programmable group of registers for readout	7534
4235	RW	7500 .. 7957	Register 36 of programmable group of registers for readout	7535
4236	RW	7500 .. 7957	Register 37 of programmable group of registers for readout	7536
4237	RW	7500 .. 7957	Register 38 of programmable group of registers for readout	7537
4238	RW	7500 .. 7957	Register 39 of programmable group of registers for readout	7538
4239	RW	7500 .. 7957	Register 40 of programmable group of registers for readout	7539
4240	RW	7500 .. 7957	Register 41 of programmable group of registers for readout	7540
4241	RW	7500 .. 7957	Register 42 of programmable group of registers for readout	7541
4242	RW	7500 .. 7957	Register 43 of programmable group of registers for readout	7542
4243	RW	7500 .. 7957	Register 44 of programmable group of registers for readout	7543
4244	RW	7500 .. 7957	Register 45 of programmable group of registers for readout	7544
4245	RW	7500 .. 7957	Register 46 of programmable group of registers for readout	7545
4246	RW	7500 .. 7957	Register 47 of programmable group of registers for readout	7546
4247	RW	7500 .. 7957	Register 48 of programmable group of registers for readout	7547
4248	RW	7500 .. 7957	Register 49 of programmable group of registers for readout	7548
4249	RW	7500 .. 7957	Register 50 of programmable group of registers for readout	7549
4250	RW	7500 .. 7957	Register 51 of programmable group of registers for readout	7550
4251	RW	7500 .. 7957	Register 52 of programmable group of registers for readout	7551
4252	RW	7500 .. 7957	Register 53 of programmable group of registers for readout	7552
4253	RW	7500 .. 7957	Register 54 of programmable group of registers for readout	7553
4254	RW	7500 .. 7957	Register 55 of programmable group of registers for readout	7554
4255	RW	7500 .. 7957	Register 56 of programmable group of registers for readout	7559
4256	RW	7500 .. 7957	Register 57 of programmable group of registers for readout	7560
4257	RW	7500 .. 7957	Register 58 of programmable group of registers for readout	7561
4258	RW	7500 .. 7957	Register 59 of programmable group of registers for readout	7566
4259	RW	7500 .. 7957	Register 60 of programmable group of registers for readout	7567
4260	RW	0,1	Restore default group 0 – no changes, 1 – restore default group	0

Table 18

16-bit register address 2x16 1032/ 2x16 3210	Register address 32-bit	Operations	Description
7200/7000	7400	R	Content of the register set in the registers 4200
7202/7002	7401	R	Content of the register set in the registers 4201
7204/7004	7402	R	Content of the register set in the registers 4202
7206/7006	7403	R	Content of the register set in the registers 4203
7208/7008	7404	R	Content of the register set in the registers 4204
7210/7010	7405	R	Content of the register set in the registers 4205
7212/7012	7406	R	Content of the register set in the registers 4206
7214/7014	7407	R	Content of the register set in the registers 4207
7216/7016	7408	R	Content of the register set in the registers 4208
7218/7018	7409	R	Content of the register set in the registers 4209
7220/7020	7410	R	Content of the register set in the registers 4210
7222/7022	7411	R	Content of the register set in the registers 4211

7224/7024	7412	R	Content of the register set in the registers 4212
7226/7026	7413	R	Content of the register set in the registers 4213
7228/7028	7414	R	Content of the register set in the registers 4214
7230/7030	7415	R	Content of the register set in the registers 4215
7232/7032	7416	R	Content of the register set in the registers 4216
7234/7034	7417	R	Content of the register set in the registers 4217
7236/7036	7418	R	Content of the register set in the registers 4218
7238/7038	7419	R	Content of the register set in the registers 4219
7240/7040	7420	R	Content of the register set in the registers 4220
7242/7042	7421	R	Content of the register set in the registers 4221
7244/7044	7422	R	Content of the register set in the registers 4222
7246/7046	7423	R	Content of the register set in the registers 4223
7248/7048	7424	R	Content of the register set in the registers 4224
7250/7050	7425	R	Content of the register set in the registers 4225
7252/7052	7426	R	Content of the register set in the registers 4226
7254/7054	7427	R	Content of the register set in the registers 4227
7256/7056	7428	R	Content of the register set in the registers 4228
7258/7058	7429	R	Content of the register set in the registers 4229
7260/7060	7430	R	Content of the register set in the registers 4230
7262/7062	7431	R	Content of the register set in the registers 4231
7264/7064	7432	R	Content of the register set in the registers 4232
7266/7066	7433	R	Content of the register set in the registers 4233
7268/7068	7434	R	Content of the register set in the registers 4234
7270/7070	7435	R	Content of the register set in the registers 4235
7272/7072	7436	R	Content of the register set in the registers 4236
7274/7074	7437	R	Content of the register set in the registers 4237
7276/7076	7438	R	Content of the register set in the registers 4238
7278/7078	7439	R	Content of the register set in the registers 4239
7280/7080	7440	R	Content of the register set in the registers 4240
7282/7082	7441	R	Content of the register set in the registers 4241
7284/7084	7442	R	Content of the register set in the registers 4242
7286/7086	7443	R	Content of the register set in the registers 4243
7288/7088	7444	R	Content of the register set in the registers 4244
7290/7090	7445	R	Content of the register set in the registers 4245
7292/7092	7446	R	Content of the register set in the registers 4246
7294/7094	7447	R	Content of the register set in the registers 4247
7296/7096	7448	R	Content of the register set in the registers 4248
7298/7098	7449	R	Content of the register set in the registers 4249
7300/7100	7450	R	Content of the register set in the registers 4250
7302/7102	7451	R	Content of the register set in the registers 4251
7304/7104	7452	R	Content of the register set in the registers 4252
7306/7106	7453	R	Content of the register set in the registers 4253
7308/7108	7454	R	Content of the register set in the registers 4254
7310/7110	7455	R	Content of the register set in the registers 4255
7312/7112	7456	R	Content of the register set in the registers 4256
7314/7114	7457	R	Content of the register set in the registers 4257
7316/7116	7458	R	Content of the register set in the registers 4258
7318/7118	7459	R	Content of the register set in the registers 4259

Table 19

Register address	Operations	Range	Description	Default
4300	RW	1...3	Luminosity level: 1 – Minimum, 2 - Medium 3 - Maximum	3
4301	RW	0 .. 3600	Time to min. luminosity	0

Register address	Operations	Range	Description	Default
4302	RW	0..7	Colors of pages	0
4303	RW	0x0001...0x1FFF	Enabling displaying pages Bit0 – page 1, Bit1 – page 2, ...Bit12 - page13	0x1FFF
4304	RW		reserved	
4305	RW	00..52	Page 1 display 1, U1	1
4306	RW	00..52	Page 1 display 2, U2	10
4307	RW	00..52	Page 1 display 3, U3	19
4308	RW	00..52	Page 1 display 4, f	37
4309	RW	00..52	Page 1 display 5, I1	2
4310	RW	00..52	Page 1 display 6, I2	11
4311	RW	00..52	Page 1 display 7, I3	20
4312	RW	00..52	Page 1 display 8, I avg	28
4313	RW	00..52	Page 2 display 1, U12	38
4314	RW	00..52	Page 2 display 2, U23	39
4315	RW	00..52	Page 2 display 3, U31	40
4316	RW	00..52	Page 2 display 4, U123	41
4317	RW	00..52	Page 2 display 5, ΣP	30
4318	RW	00..52	Page 2 display 6, ΣQ	31
4319	RW	00..52	Page 2 display 7, ΣS	32
4320	RW	00..52	Page 2 display 8, PF avg	33
4321	RW	00..52	Page 3 display 1, P1	3
4322	RW	00..52	Page 3 display 2, P2	12
4323	RW	00..52	Page 3 display 3, P3	21
4324	RW	00..52	Page 3 display 4, ΣP	30
4325	RW	00..52	Page 3 display 5, PF1	6
4326	RW	00..52	Page 3 display 6, PF2	15
4327	RW	00..52	Page 3 display 7, PF3	24
4328	RW	00..52	Page 3 display 8, PF avg	33
4329	RW	00..52	Page 4 display 1, P1	3
4330	RW	00..52	Page 4 display 2, P2	12
4331	RW	00..52	Page 4 display 3, P3	21
4332	RW	00..52	Page 4 display 4, ΣP	30
4333	RW	00..52	Page 4 display 5, Q1	4
4334	RW	00..52	Page 4 display 6, Q2	13
4335	RW	00..52	Page 4 display 7, Q3	22
4336	RW	00..52	Page 4 display 8, ΣQ	31
4337	RW	00..52	Page 5 display 1, THD U1	8
4338	RW	00..52	Page 5 display 2, THD U2	17
4339	RW	00..52	Page 5 display 3, THD U3	26
4340	RW	00..52	Page 5 display 4, THD U	35
4341	RW	00..52	Page 5 display 5, THD I1	9
4342	RW	00..52	Page 5 display 6, THD I2	18
4343	RW	00..52	Page 5 display 7, THD I3	27
4344	RW	00..52	Page 5 display 8, THD I	36
4345	RW	00..52	Page 6 display 1, U1	1
4346	RW	00..52	Page 6 display 2, I1	2
4347	RW	00..52	Page 6 display 3, P1	3
4348	RW	00..52	Page 6 display 4, Q1	4
4349	RW	00..52	Page 6 display 5, S1	5
4350	RW	00..52	Page 6 display 6, PF1	6
4351	RW	00..52	Page 6 display 7, tg1	7
4352	RW	00..52	Page 6 display 8, f	37
4353	RW	00..52	Page 7 display 1, U2	10
4354	RW	00..52	Page 7 display 2, I2	11

Register address	Operations	Range	Description	Default
4355	RW	00..52	Page 7 display 3, P2	12
4356	RW	00..52	Page 7 display 4, Q2	13
4357	RW	00..52	Page 7 display 5, S2	14
4358	RW	00..52	Page 7 display 6, PF2	15
4359	RW	00..52	Page 7 display 7, tg2	16
4360	RW	00..52	Page 7 display 8, f	37
4361	RW	00..52	Page 8 display 1, U3	19
4362	RW	00..52	Page 8 display 2, I3	20
4363	RW	00..52	Page 8 display 3, P3	21
4364	RW	00..52	Page 8 display 4, Q3	22
4365	RW	00..52	Page 8 display 5, S3	23
4366	RW	00..52	Page 8 display 6, PF3	24
4367	RW	00..52	Page 8 display 7, tg3	25
4368	RW	00..52	Page 8 display 8, f	37
4369	RW	00..52	Page 9 display 1, Σ P	30
4370	RW	00..52	Page 9 display 2, Σ Q	31
4371	RW	00..52	Page 9 display 3, I avg	29
4372	RW	00..52	Page 9 display 4, I(N)	45
4373	RW	00..52	Page 9 display 5, P DMD	42
4374	RW	00..52	Page 9 display 6, S DMD	43
4375	RW	00..52	Page 9 display 7, I DMD	44
4376	RW	00..52	Page 9 display 8, f	37
4377	RW	00..52	Page 10 display 1, Σ P	30
4378	RW	00..52	Page 10 display 2, Σ Q	31
4379	RW	00..52	Page 10 display 3, Σ S	32
4380	RW	00..52	Page 10 display 4, En S	52
4381	RW	00..52	Page 10 display 5, +En P	48
4382	RW	00..52	Page 10 display 6, -En P	49
4383	RW	00..52	Page 10 display 7, Σ En Q	50
4384	RW	00..52	Page 10 display 8, Σ En Q	51
4385	RW	0..3	Restore manufacturer's pages 0 - no 1 - 3Ph/4W 2 - 3Ph/3W 3 - 1PH/2W	0
4386	RW	00..47	The quantity displayed on the analog indicator: 0-Off, 1-U1, 2-I1, ...47-T2	1
4387	RW	-1440 .. 1440	Bottom scale	0
4388	RW	-1440 .. 1440	Upper scale	100

Table 20

Register address	Operations	Range	Description	Default
4400	R		reserved	
4401	R	0..65535	Identifier	D9
4402	R	0..65535	Bootloader version x 100	-
4403	R	0..65535	Program version x100	-
4404	R		reserved	
4405	R	0..65535	Ordering codes	-
4406	R	0..65535	Nominal voltage x10	577/2300
4407	R	0..65535	Nominal voltage x10	1100/4000
4408	R	0..65535	Nominal current (1 A) x 100	100

4409	R	0..65535	Nominal current (5 A) x 100	500
4410	R		reserved	
4411	R	0..65535	Seventh and sixth byte (B7.B6) of a serial number, format B7:B6:B5:B4:B3:B2:B1:B0	-
4412	R	0..65535	Fifth and fourth byte (B5.B4) of a serial number, format B7:B6:B5:B4:B3:B2:B1:B0	-
4413	R	0..65535	Third and second byte (B3.B2) of a serial number, format B7:B6:B5:B4:B3:B2:B1:B0	-
4414	R	0..65535	First and zero byte (B1.B0) of a serial number, format B7:B6:B5:B4:B3:B2:B1:B0	-
4415	R	0..65535	Status 1 Register – see description below	0
4416	R	0..65535	Status 2 Register – see description below	0
4417	R	0..65535	Status 3 Register – see description below	0
4418	R	0..65535	Status 4 Register – see description below	0
4419	R	0..65535	Status 5 Register – see description below	0
4420	R	0..65535	Status 6 Register – see description below	0
4421	R	0... 65535	Fifth and fourth byte (B5.B4) of MAC address of the meter, format B5:B4:B3:B2:B1:B0	-
4422	R	0... 65535	Third and second byte (B3.B2) of MAC address of the meter, format B5:B4:B3:B2:B1:B0	-
4423	R	0... 65535	The fifth and fourth byte (B1.B0) of MAC address of the meter, format B5:B4:B3:B2:B1:B0	-
4424	R	0... 65535	Status register 7– description below	0
4425	R		reserved	0
4426	R	0..152	Active import energy, two older bytes	0
4427	R	0..65535	Active import energy, two younger bytes	0
4428	R	0..152	Active export energy, two older bytes	0
4429	R	0..65535	Active export energy, two younger bytes	0
4430	R	0..152	Reactive inductive energy, two older bytes	0
4431	R	0..65535	Reactive inductive energy, two younger bytes	0
4432	R	0..152	Reactive capacity energy, two older bytes	0
4433	R	0..65535	Reactive capacity energy, two younger bytes	0
4434	R	0..152	Apparent energy, two older bytes	0
4435	R	0..65535	Apparent energy, two younger bytes	0
4436	R		reserved	
4437	R		reserved	
4438	R	0..2000	Resistance Pt100 x100 (T1)	-
4439	R	0..2000	Resistance Pt100 x100 (T2)	-
4440	R	0..1000	Files archive usage in ‰	0
4441	R	0..1000	Group 1 archive internal memory usage in ‰	0
4442	R	0..1000	Group 2 archive internal memory usage in ‰	0
4443	R	0..1000	Total archive internal memory usage for the groups 1 and 2 in ‰	0
4444	R	0..1000	Percentage of the archive copying progress to files archive for group 1 in ‰	0
4445	R	0..1000	Percentage of the archive copying progress to files archive for group 2 in ‰	0
4446	R	0..1000	Total percentage of the archive copying progress to files archive for group 1 and 2 in ‰	0

Energy is made available in hundreds of watt-hours (var-hours) in double 16-bit register, and for this reason, you should divide them by 100 when calculating values of particular energy from registers, e.g.:

Active import energy = (reg. value 4426 x 65536 + reg. value 4427) / 100 [kWh]

Active export energy = (reg. value 4428 x 65536 + reg. value 4429) / 100 [kWh]

Reactive inductive energy = (reg. value 4430 x 65536 + reg. value 4431) / 100 [kVarh]

Reactive capacity energy = (reg. value 4432 x 65536 + reg. value 4433) / 100 [kVarh]

Apparent energy = (reg. value 4434 x 65536 + reg. value 4435) / 100 [kVAh]

Status 1 Register of a device (address 4415, R):

Bit 15 – "1" – FRAM memory damage	Bit 7 – "1" – phase sequence error
Bit 14 – "1" – no calibration of the input	Bit 6 – "1" – reserved
Bit 13 – "1" – no calibration of the output	Bit 5 – "1" – reserved
Bit 12 – "1" – PT100 calibration error	Bit 4 – "1" – present analog output
Bit 11 – "1" – error in configuration registers	Bit 3 – "1" – present PT100
Bit 10 – "1" – error in displayed pages registers	Bit 2 – "1" – present Ethernet and internal memory
Bit 9 – "1" – error in registers for configuration of programmable group of registers for readout	Bit 1 – "1" – used battery of RTC
Bit 8 – "1" – energy value error	Bit 0 – reserved

Status 2 Register – (address 4416, R):

Bit 15 – "1" – condition 3 for alarm 2 signalization	Bit 7 – "1" – condition 3 for alarm 1 signalization
Bit 14 – "1" – condition 2 for alarm 2 signalization	Bit 6 – "1" – condition 2 for alarm 1 signalization
Bit 13 – "1" – condition 1 for alarm 2 signalization	Bit 5 – "1" – condition 1 for alarm 1 signalization
Bit 12 – "1" – alarm 2 signalization	Bit 4 – "1" – alarm 1 signalization
Bit 11 – "1" – alarm 2 condition 3 activated	Bit 3 – "1" – alarm 1 condition 3 activated
Bit 10 – "1" – alarm 2 condition 2 activated	Bit 2 – "1" – alarm 1 condition 2 activated
Bit 9 – "1" – alarm 2 condition 1 activated	Bit 1 – "1" – alarm 1 condition 1 activated
Bit 8 – "1" – alarm 2 activated	Bit 0 – "1" – alarm 1 activated

Status 3 Register – (address 4417, R): Files archive status

Bit 15 – Ethernet connected	Bit 7 – Archiving group 1 enabled
Bit 14 – reserved	Bit 6 – reserved
Bit 13 – reserved	Bit 5 – copying of internal memory to files archive from archiving group 2
Bit 12 – reserved	Bit 4 – copying of internal memory to files archive from archiving group 1
Bit 11 – "0" - waiting for the archiving conditions to be met "1" - archiving in the archiving group 2	Bit 3 – Files archive space is full, (less then 14 days at 1 sec. interval to completely use a the files archive space)
Bit 10 – "0" - waiting for the archiving conditions to be met "1" - archiving in the archiving group 1	Bit 2 – 70% of files archive space is full
Bit 9 – reserved	Bit 1 – Files archive initialized correctly
Bit 8 – Archiving group 2 enabled	Bit 0 – Files archive file system error

Status 4 Register – (address 4418, R) reactive power characteristics:

Bit 15 – measurement with phase L3 synchronization	Bit 7 – "1" – capacity L3 min.
Bit 14 – measurement with phase L2 synchronization	Bit 6 – "1" – capacity L3
Bit 13 – measurement with phase L1 synchronization	Bit 5 – "1" – capacity L2 max.
Bit 12 – measurement with current synchronization	Bit 4 – "1" – capacity L2 min.
Bit 11 – "1" – capacity 3L max.	Bit 3 – "1" – capacity L2
Bit 10 – "1" – capacity 3L min.	Bit 2 – "1" – capacity L1 max.
Bit 9 – "1" – capacity 3L	Bit 1 – "1" – capacity L1 min.
Bit 8 – "1" – leading L3 max.	Bit 0 – "1" – capacity L1

Status 5 Register – (address 4419, R)

Bit 8 – "1" – alarm 1 condition 3 for phase L3 active
 Bit 7 – "1" – alarm 1 condition 3 for phase L2 active
 Bit 6 – "1" – alarm 1 condition 3 for phase L1 active
 Bit 5 – "1" – alarm 1 condition 2 for phase L3 active
 Bit 4 – "1" – alarm 1 condition 2 for phase L2 active
 Bit 3 – "1" – alarm 1 condition 2 for phase L1 active
 Bit 2 – "1" – alarm 1 condition 1 for phase L3 active
 Bit 1 – "1" – alarm 1 condition 1 for phase L2 active
 Bit 0 – "1" – alarm 1 condition 1 for phase L1 active

Status 6 Register – (address 4420, R)

Bit 8 – "1" – alarm 2 condition 3 for phase L3 active
 Bit 7 – "1" – alarm 2 condition 3 for phase L2 active
 Bit 6 – "1" – alarm 2 condition 3 for phase L1 active
 Bit 5 – "1" – alarm 2 condition 2 for phase L3 active
 Bit 4 – "1" – alarm 2 condition 2 for phase L2 active
 Bit 3 – "1" – alarm 2 condition 2 for phase L1 active
 Bit 2 – "1" – alarm 2 condition 1 for phase L3 active
 Bit 1 – "1" – alarm 2 condition 1 for phase L2 active
 Bit 0 – "1" – alarm 2 condition 1 for phase L1 active

Status 7 Register – (address 4424, R)

Bit 8 – reserved
 Bit 7 – reserved
 Bit 6 – reserved
 Bit 5 – reserved
 Bit 4 – reserved
 Bit 3 – reserved
 Bit 2 – reserved
 Bit 1 – „1" – MQTT protocol functions disabled
Bit 0 – reserved

Table 20A

Register address	Operations	Range	Description	Default
4500	R	0xFFFF, 0x0, 0x1	Connection status with the MQTT server: 0xFFFF - no connection, 0x0 - attempt to establish a connection, 0x1 - connection has been established.	0xFFFF
4501	RW	0x0000-0xFEFE	The first and second byte of the IP address of the MQTT broker (B1:B2).	0x25BB
4502	RW	0x0000-0xFEFE	The third and fourth byte of the IP address of the MQTT broker (B3:B4).	0x6A10
4503	RW	0x0001-0xFFFFE	Port number of MQTT broker	1883
4504	RW	1 .. 3600	Period after which data are published (in seconds).	5
4505	RW	0..1	Saving configuration to non-volatile memory: 0 – no changes, 1 – save changes.	0

4506	RW	0..1	Enabling or disabling data publishing for the MQTT server: 0 - data not published, 1 - publishing data to the server.	0
4507-4517	RW	0x2D, 0x20, 0x2E, 0x30-0x39 (digits), 0x41-0x5A (uppercase letters), 0x61-0x7A (lowercase letters)	The MQTT client name written with two characters for each register. For example, the client's name in the form 12345 will be saved in the registers as follows: 4507: 3132, 4508: 3334, 4509: 3500.	
4518-4528	RW	0x2D, 0x20, 0x2E, 0x30-0x39 (digits), 0x41-0x5A (uppercase letters), 0x61-0x7A (lowercase letters)	The MQTT topic name written with two characters for each register. For example, the topic name in the form 23456 will be saved in the registers as follows: 4518: 3233, 4519: 3435, 4520: 3600.	

Table 21

16-bit register address 2x16 1032/ 2x16 3210	Register address 32-bit	Operations	Description	Unit	3Ph / 4W	3Ph / 3W	1Ph / 2W
6000/8000	7500	R	L1 phase voltage	V	√	x	√
6002/8002	7501	R	L1 phase current	A	√	√	√
6004/8004	7502	R	L1 phase active power	W	√	x	√
6006/8006	7503	R	L1 phase reactive power	VA _r	√	x	√
6008/8008	7504	R	L1 phase apparent power	VA	√	x	√
6010/8010	7505	R	L1 phase active power factor (PF1=P1/S1))	-	√	x	√
6012/8012	7506	R	tgφ factor of L1 phase (tg1=Q1/P1)	-	√	x	√
6014/8014	7507	R	THD U1*	%	√	x	√
6016/8016	7508	R	THD I1	%	√	x	√
6018/8018	7509	R	L2 phase voltage	V	√	x	x
6020/8020	7510	R	L2 phase current	A	√	√	x
6022/8022	7511	R	L2 phase active power	W	√	x	x
6024/8024	7512	R	L2 phase reactive power	VA _r	√	x	x
6026/8026	7513	R	L2 phase apparent power	VA	√	x	x
6028/8028	7514	R	L2 phase active power factor (PF2=P2/S2))	-	√	x	x
6030/8030	7515	R	tgφ factor of L2 phase (tg2=Q2/P2)	-	√	x	x
6032/8032	7516	R	THD U2*	%	√	√	x
6034/8034	7517	R	THD I2	%	√	√	x
6036/8036	7518	R	L3 phase voltage	V	√	x	x
6038/8038	7519	R	L3 phase current	A	√	√	x
6040/8040	7520	R	L3 phase active power	W	√	x	x
6042/8042	7521	R	L3 phase reactive power	VA _r	√	x	x
6044/8044	7522	R	L3 phase apparent power	VA	√	x	x
6046/8046	7523	R	L3 phase active power factor (PF3=P3/S3)	-	√	x	x
6048/8048	7524	R	tgφ factor of L3 phase (tg3=Q3/P3)	-	√	x	x

6050/8050	7525	R	THD U3*	%	√	√	x
6052/8052	7526	R	THD I3	%	√	√	x
6054/8054	7527	R	Mean 3-phase voltage	V	√	x	x
6056/8056	7528	R	Mean 3-phase current	A	√	√	x
6058/8058	7529	R	3-phase active power (P1+P2+P3)	W	√	√	x
6060/8060	7530	R	3-phase reactive power (Q1+Q2+Q3)	VAr	√	√	x
6062/8062	7531	R	3-phase apparent power (S1+S2+S3)	VA	√	√	x
6064/8064	7532	R	3-phase active power factor (PF=P/S)	-	√	√	x
6066/8066	7533	R	Mean tg factor ϕ for 3 phases (tg=Q/P)	-	√	√	x
6068/8068	7534	R	THD U* mean 3-phase	%	√	√	x
6070/8070	7535	R	THD I mean 3-phase	%	√	√	x
6072/8072	7536	R	Frequency	f	√	√	√
6074/8074	7537	R	Phase-to-phase voltage L ₁₋₂	V	√	√	x
6076/8076	7538	R	Phase-to-phase voltage L ₂₋₃	V	√	√	x
6078/8078	7539	R	Phase-to-phase voltage L ₃₋₁	V	√	√	x
6080/8080	7540	R	Mean phase-to-phase voltage	V	√	√	x
6082/8082	7541	R	Active power averaged (P Demand)	W	√	√	x
6084/8084	7542	R	Reactive power averaged (S Demand)	VA	√	√	x
6086/8086	7543	R	Current averaged (I Demand)	A	√	√	x
6088/8088	7544	R	Neutral wire current (calculated from vectors)	A	√	x	x
6090/8090	7545	R	Active 3-phase import energy (no. of register 7546 overflows, resets to 0 after reaching 9999.9 MWh)	100 MWh	√	√	√
6092/8092	7546	R	Active 3-phase import energy (counter counting up to 99999.99 kWh)	kWh	√	√	√
6094/8094	7547	R	Active 3-phase export energy (no. of register 7548 overflows, resets to 0 after reaching 9999.9 MWh)	100 MWh	√	√	√
6096/8096	7548	R	Active 3-phase export energy (counter counting up to 99999.99 kWh)	kWh	√	√	√
6098/8098	7549	R	Reactive 3-phase inductive energy (no. of register 7550 overflows, resets to 0 after reaching 9999.9 MVAh).	100 MVAh	√	√	√
6100/8100	7550	R	Reactive 3-phase inductive energy (counter counting up to 99999.99 kVAh)	kVAh	√	√	√
6102/8102	7551	R	Reactive 3-phase capacity energy (no. of register 7552 overflows, resets to 0 after reaching 9999.9 MVAh)	100 MVAh	√	√	√
6104/8104	7552	R	Reactive 3-phase capacity energy (counter counting up to 99999.99 kVAh)	kVAh	√	√	√
6106/8106	7553	R	Apparent energy (no. of register 7554 overflows, resets to 0 after reaching 9999.9 MVAh)	100 MVAh	√	√	√
6108/8108	7554	R	Apparent energy (counter counting up to 99999.99 kVAh)	kVAh	√	√	√
6110/8110	7555	R	Time – seconds	sec	√	√	√
6112/8112	7556	R	Time – hours, minutes		√	√	√
6114/8114	7557	R	Date – month, day		√	√	√
6116/8116	7558	R	Year – 2014 - 2100		√	√	√
6118/8118	7559	R	Status 1 register	-	√	√	√
6120/8120	7560	R	Status 2 register	-	√	√	√
6122/8122	7561	R	Status 3 register	-	√	√	√
6124/8124	7562	R	Status 4 register	-	√	√	√
6126/8126	7563	R	Status 5 register	-	√	√	√
6128/8128	7564	R	Status 6 register	-	√	√	√
6130/7130	7565	R	Continuous output 1 activation	mA	√	√	√
6132/8132	7566	R	Temperature Pt100 1	°C	√	√	√

6134/8134	7567	R	Temperature Pt100 2	°C	√	√	√
6136/8136	7568	R	Voltage L1 min	V	√	x	√
6138/8138	7569	R	Voltage L1 max	V	√	x	√
6140/8140	7570	R	Voltage L2 min	V	√	x	x
6142/8142	7571	R	Voltage L2 max	V	√	x	x
6144/8144	7572	R	Voltage L3 min	V	√	x	x
6146/8146	7573	R	Voltage L3 max	V	√	x	x
6148/8148	7574	R	Current L1 min	A	√	√	x
6150/8150	7575	R	Current L1 max	A	√	√	x
6152/8152	7576	R	Current L2 min	A	√	√	x
6154/8154	7577	R	Current L2 max	A	√	√	x
6156/8156	7578	R	Current L3 min	A	√	√	x
6158/8158	7579	R	Current L3 max	A	√	√	x
6160/8160	7580	R	Active power L1 min	W	√	x	√
6162/8162	7581	R	Active power L1 max	W	√	x	√
6164/8164	7582	R	Active power L2 min	W	√	x	x
6166/8166	7583	R	Active power L2 max	W	√	x	x
6168/8168	7584	R	Active power L3 min	W	√	x	x
6170/8170	7585	R	Active power L3 max	W	√	x	x
6172/8172	7586	R	Reactive power L1 min	Var	√	x	√
6174/8174	7587	R	Reactive power L1 max	Var	√	x	√
6176/8176	7588	R	Reactive power L2 min	Var	√	x	x
6178/8178	7589	R	Reactive power L2 max	Var	√	x	x
6180/8180	7590	R	Reactive power L3 min	Var	√	x	x
6182/8182	7591	R	Reactive power L3 max	Var	√	x	x
6184/8184	7592	R	Apparent power L1 min	VA	√	x	√
6186/8186	7593	R	Apparent power L1 max	VA	√	x	√
6188/8188	7594	R	Apparent power L2 min	VA	√	x	x
6190/8190	7595	R	Apparent power L2 max	VA	√	x	x
6192/8192	7596	R	Apparent power L3 min	VA	√	x	x
6194/8194	7597	R	Apparent power L3 max	VA	√	x	x
6196/8196	7598	R	Power factor (PF) L1 min	-	√	x	√
6198/8198	7599	R	Power factor (PF) L1 max	-	√	x	√
6200/8200	7600	R	Power factor (PF) L2 min	-	√	x	x
6202/8202	7601	R	Power factor (PF) L2 max	-	√	x	x
6204/8204	7602	R	Power factor (PF) L3 min	-	√	x	x
6206/8206	7603	R	Power factor (PF) L3 max	-	√	x	x
6208/8208	7604	R	Reactive to active power ratio L1 min	-	√	x	√
6210/8210	7605	R	Reactive to active power ratio L1 max	-	√	x	√
6212/8212	7606	R	Reactive to active power ratio L1 min	-	√	x	x
6214/8214	7607	R	Reactive to active power ratio L2 max	-	√	x	x
6216/8216	7608	R	Reactive to active power ratio L3 min	-	√	x	x
6218/8218	7609	R	Reactive to active power ratio L3 max	-	√	x	x
6220/8220	7610	R	Phase-to-phase voltage L ₁₋₂ min	V	√	√	x
6222/8222	7611	R	Phase-to-phase voltage L ₁₋₂ max	V	√	√	x
6224/8224	7612	R	Phase-to-phase voltage L ₂₋₃ min	V	√	√	x
6226/8226	7613	R	Phase-to-phase voltage L ₂₋₃ max	V	√	√	x
6228/8228	7614	R	Phase-to-phase voltage L ₃₋₁ min	V	√	√	x
6230/8230	7615	R	Phase-to-phase voltage L ₃₋₁ max	V	√	√	x
6232/8232	7616	R	Mean 3-phase voltage (min)	V	√	x	x
6234/8234	7617	R	Mean 3-phase voltage (max)	V	√	x	x

6236/8236	7618	R	Mean 3-phase current (min)	A	√	√	x
6238/8238	7619	R	Mean 3-phase current (max)	A	√	√	x
6240/8240	7620	R	3-phase active power (min)	W	√	√	x
6242/8242	7621	R	3-phase active power (max)	W	√	√	x
6244/8244	7622	R	3-phase reactive power (min)	var	√	√	x
6246/8246	7623	R	3-phase reactive power (max)	var	√	√	x
6248/8248	7624	R	3-phase apparent power (min)	VA	√	√	x
6250/8250	7625	R	3-phase apparent power (max)	VA	√	√	x
6252/8252	7626	R	Power factor (PF) min	-	√	√	x
6254/8254	7627	R	Power factor (PF) max	-	√	√	x
6256/8256	7628	R	Reactive to active power ratio (3-phase mean min.)	-	√	√	x
6258/8258	7629	R	Reactive to active power ratio (3-phase mean max.)	-	√	√	x
6260/8260	7630	R	Min. frequency	Hz	√	√	√
6262/8262	7631	R	Frequency max	Hz	√	√	√
6264/8264	7632	R	Mean phase-to-phase voltage (min.)	V	√	√	x
6266/8266	7633	R	Mean phase-to-phase voltage (max.)	V	√	√	x
6268/8268	7634	R	Active power averaged (P Demand) min	W	√	√	√
6270/8270	7635	R	Active power averaged (P Demand) max	W	√	√	√
6272/8272	7636	R	Apparent power averaged (S Demand) min	VA	√	√	√
6274/8274	7637	R	Apparent power averaged (S Demand) max	VA	√	√	√
6276/8276	7638	R	Current averaged (I Demand) min	A	√	√	√
6278/8278	7639	R	Current averaged (I Demand) max	A	√	√	√
6280/8280	7640	R	Neutral wire current (min.)	A	√	x	x
6282/8282	7641	R	Neutral wire current (max.)	A	√	x	x
6284/8284	7642	R	Temperature T1 min	°C	√	√	√
6286/8286	7643	R	Temperature T1 max	°C	√	√	√
6288/8288	7644	R	Temperature T2 min	°C	√	√	√
6290/8290	7645	R	Temperature T2 max	°C	√	√	√
6292/8292	7646	R	THD U1 min	%	√	x	√
6294/8294	7647	R	THD U1 max	%	√	x	√
6296/8296	7648	R	THD U2 min	%	√	x	x
6298/8298	7649	R	THD U2 max	%	√	x	x
6300/8300	7650	R	THD U3 min	%	√	x	x
6302/8302	7651	R	THD U3 max	%	√	x	x
6304/8304	7652	R	THD U min	%	√	x	x
6306/8306	7653	R	THD U max	%	√	x	x
6308/8308	7654	R	THD I1 min	%	√	x	√
6310/8310	7655	R	THD I1 max	%	√	x	√
6312/8312	7656	R	THD I2 min	%	√	x	x
6314/8314	7657	R	THD I2 max	%	√	x	x
6316/8316	7758	R	THD I3 min	%	√	x	x
6318/8318	7759	R	THD I3 max	%	√	x	x
6320/8320	7660	R	THD I min	%	√	x	x
6322/8322	7661	R	THD I max	%	√	x	x
6324/8324	7662	R	HarU1[2] 2nd harmonic of L1 phase voltage	%	√	x	√
6326/8326	7663	R	HarU1[3] 3rd harmonic of L1 phase voltage	%	√	x	√
:	:	R	:				
:	:	R	:				

6420/8420	7710	R	HarU1[50] 50th harmonic of L1 phase voltage	%	√	x	√
6422/8422	7711	R	HarU1[51] 51st harmonic of L1 phase voltage	%	√	x	√
6424/8424	7712	R	HarU2[2] 2nd harmonic of L2 phase voltage	%	√	x	x
6426/8426	7713	R	HarU2[3] 3rd harmonic of L2 phase voltage	%	√	x	x
:	:	R	:				
:	:	R	:				
6520/8520	7760	R	HarU2[50] 50th harmonic of L2 phase voltage	%	√	x	x
6522/8522	7761	R	HarU2[51] 51st harmonic of L2 phase voltage	%	√	x	x
6524/8524	7762	R	HarU3[2] 2nd harmonic of L3 phase voltage	%	√	x	x
6526/8526	7763	R	HarU3[3] 3rd harmonic of L3 phase voltage	%	√	x	x
:	:	R	:				
:	:	R	:				
6620/8620	7810	R	HarU3[50] 50th harmonic of L3 phase voltage	%	√	x	x
6622/8622	7811	R	HarU3[51] 51st harmonic of L3 phase voltage	%	√	x	x
6624/8624	7812	R	HarI1U1[2] 2nd harmonic of L1 phase current	%	√	x	√
6626/8626	7813	R	HarI1U1[3] 3rd harmonic of L1 phase current	%	√	x	√
:	:	R	:				
:	:	R	:				
6720/8720	7860	R	HarI1U1[50] 50th harmonic of L1 phase current	%	√	x	√
6722/8722	7861	R	HarI1[51] 51st harmonic of L1 phase current	%	√	x	√
6724/8724	7862	R	HarI2[2] 2nd harmonic of L2 phase current	%	√	x	x
6726/8726	7863	R	HarI2[3] 3rd harmonic of L2 phase current	%	√	x	x
:	:	R	:				
:	:	R	:				
6820/8820	7910	R	HarI2[50] 50th harmonic of L2 phase current	%	√	x	x
6822/8822	7911	R	HarI2[51] 51st harmonic of L2 phase current	%	√	x	x
6824/8824	7912	R	HarI3[2] 2nd harmonic of L3 phase current	%	√	x	x
6826/8826	7913	R	HarI3[3] 3rd harmonic of L3 phase current	%	√	x	x
:	:	R	:				
:	:	R	:				
6920/8920	7960	R	HarI3[50] 50th harmonic of L3 phase current	%	√	x	x
6922/8922	7961	R	HarI3[51] 51st harmonic of L3 phase current	%	√	x	x

* In the 3-phase 3-wire (3Ph / 3W) respectively THD U12, THD U23, THD U31, THD U123

11 SOFTWARE UPGRADE

11.1 Upgrade of the meter website

Upgrade can be done via FTP server.

You can upgrade the website in the tab *Website upgrade*. Copy the file **ND30IoT_upd.tar** to the main folder of the meter. Then turn off and turn on the meter, i.e. reset the meter. The file ND30IoT_upd.tar will be extracted to the appropriate folders. It can take approx. 1 minute. The messages informing about the progress of extracting will be displayed on the meter screen.

a)

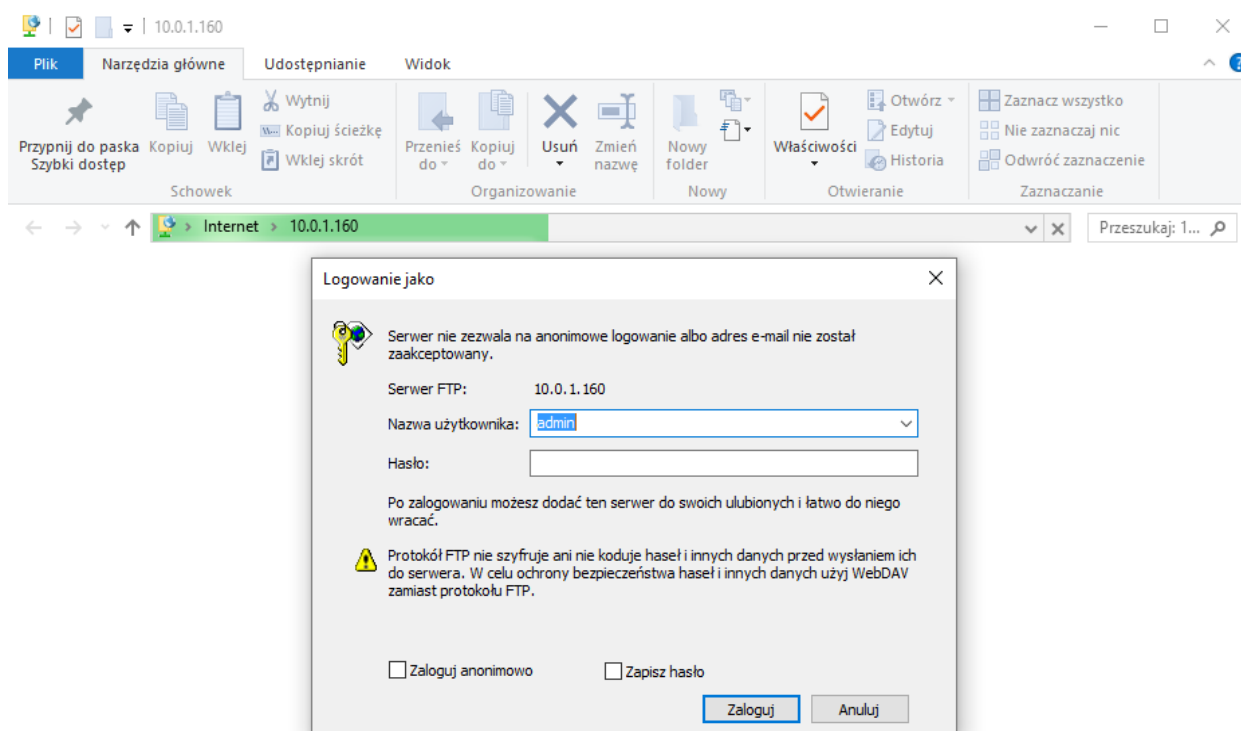

b)

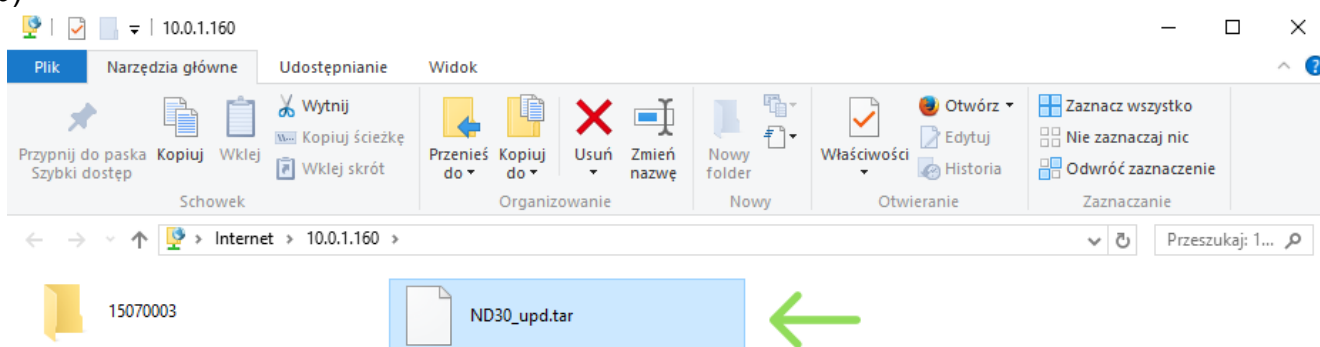

Fig. 32. View of the window a) logging on, b) website upgrade file

11.2 Firmware update - main program of the meter

A feature implemented in the ND30IoT meters enables to upgrade firmware using a PC with eCon software installed. Free eCon software and the update files are available at www.lumel.com.pl. Upgrade of meter software (firmware) can be done via RS-485 interface. Go to LUMEL UPDATER tab to upgrade.

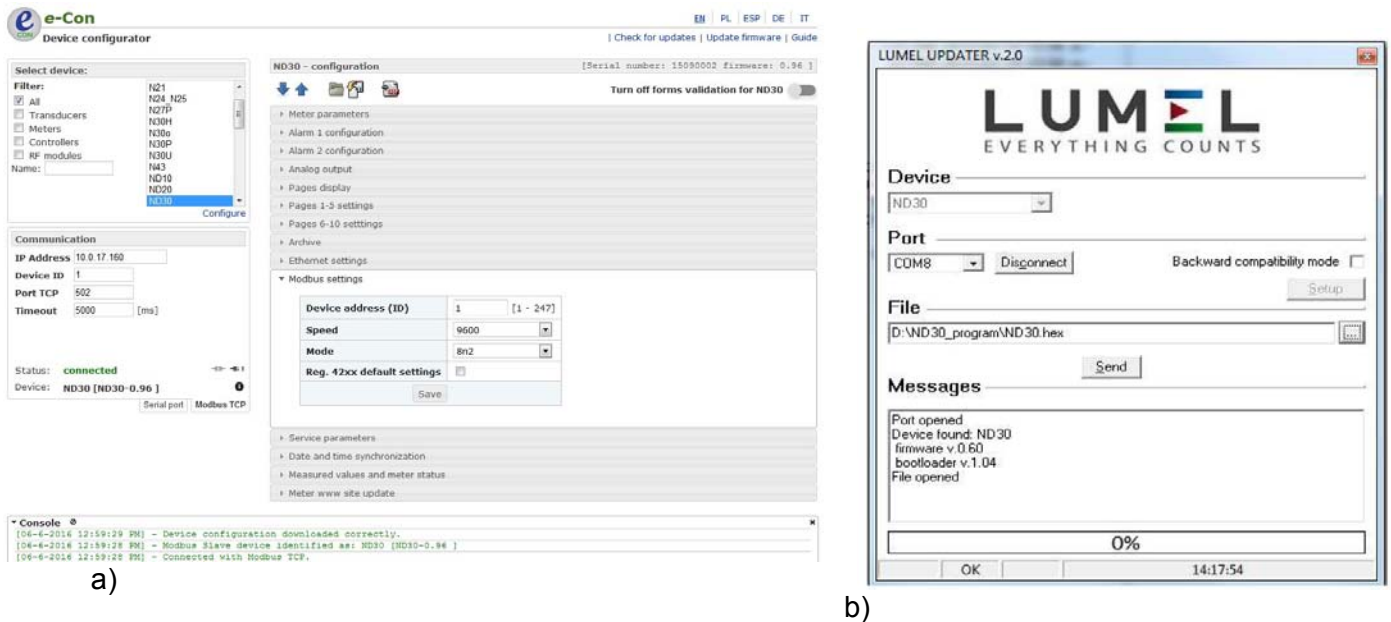



Fig. 33. Program window view: a) eCon, b) software upgrade



Note: Software update automatically resets meter settings to default settings, so it is recommended to save meter settings using eCon software before upgrading.

After launching eCon software, set in the settings required serial port, baud rate, mode and address of the meter. Next, select the ND30/ND30IoT meter and click *Config*. Click the down arrow icon to read all of the settings then the disk icon to save the settings to a file (required to restore the settings later). After selecting the option *Update firmware* (in the upper right corner of the screen) the window *Lumel Updater (LU)* will be opened – Fig. 33b. Click *Connect*. The *Messages* information window displays information concerning upgrade process. If the port is opened correctly, a *Port opened* message appears. Upgrade mode is enabled using either of the two methods: remotely via LU (using LCon settings: address, mode, baud rate, COM port) and by turning a meter on while pressing the button  (while entering bootloader mode the button is used to set communication settings: baud rate 9600, RTU8N2, address 1). The display will show the bootloader version, while the LU program displays the message *Device found* and the name and version of the connected device. Click the "...” button and browse to the meter upgrade file. If the file is opened correctly, *File opened* message is displayed. Press the *Send* button. When upgrade is successfully completed, the meter begins normal work while the information window displays *Done* message and upgrade elapsed time. After the LU window is closed, go to parameter group *Service parameters*, select the option *Set default settings of a meter* and press a button *Restore*. Then press the folder icon to open a previously saved settings file and press the up arrow icon to save the settings in the meter. Current software version can be checked by reading the welcome message when switching the meter on.

Note: Turning meter supply off during upgrade process may result in permanent damage!

12 ERROR CODES

During the meter operation the error messages may be displayed. Following list shows reasons of errors.

- **Err bat** – displayed when the battery of the internal RTC clock is used up. Measurement is carried out after switching the supply on and every day at midnight. The message can be turned off by pressing the button . The disabled message remains inactive till the renewed switching of the meter on.
- **Err CAL, Err EE** – meter memory is damaged. In such case a meter should be sent back to the manufacturer.
- **Err PAr** – incorrect operational parameters of the meter. In such case a meter should be set to default settings (from menu or via RS-485 interface). The message can be turned off by pressing the button .
- $\wedge\wedge\wedge$ – upper overrun. Measuring value is out of the measuring range.
- $\vee\vee\vee$ – lower overrun. Measuring value is out of the measuring range.

13 TECHNICAL DATA

Measuring ranges and permissible basic errors

Table 22

Measuring value	Measuring range	L 1	L2	L3	Σ	Class
Current I 1/5 A 1 A~ 5 A~	0.002 ..0.100..1.200 A 0.010 ..0.500.. 6.000 A ...100.00 kA (tr I≠1)	•	•	•		0.2 (EN 61557-12)
Voltage U L-N: 57.7 V~ 110 V~ 230 V~ 400 V~	5.700..11.500 ..70.000 V 11.000..22.000 ..132.00 V 23.000..46.000 .. 276.00 V 40.000..80.000 .. 480.00 V ...1920.0 kV	•	•	•		0.2 (EN 61557-12)
Voltage U L-L: 100 V~ 190 V~ 400 V~ 690 V~	10.000 ..20.000..120.00 V 19.000 ..38.000..228.00 V 40.000..80.00 .. 480.00 V 69.000..138.00 .. 830.00 V ...1999.0 kV (tr U≠1)	•	•	•		0.5 (EN 61557-12)
Active power P	-19999 MW .. 0.000 W19999 MW (tr U≠1, tr I≠1)	•	•	•	•	0.5 (EN 61557-12)
Reactive power Q	-19999 MVar .. 0.000 Var19999 MVar (tr U≠1, tr I≠1)	•	•	•	•	1 (EN 61557-12)
Apparent power S	0.000 .. 1999,9 VA19999 MVA (tr U≠1, tr I≠1)	•	•	•	•	0.5 (EN 61557-12)
Active energy EnP / import or export /	0.000 .. 99 999 999.999 kWh				•	0.5 ¹⁾ (EN 61557-12)
Reactive energy EnQ / capacity or inductive /	0.000 .. 99 999 999.999 kVarh				•	1 (EN 61557-12)
Apparent energy EnS	0.000 .. 99 999 999.999 kVAh				•	0.5 (EN 61557-12)
Active power factor PF	-1.00 .. 0 .. 1.00	•	•	•	•	1 (EN 61557-12)

Factor tg	<u>-1.20 .. 0 .. 1.20</u>	•	•	•	•	1
Frequency f	<u>45.000 .. 65.000 Hz</u>				•	0.1 (EN 61557-12)
Harmonic distortion factor of voltage THDU, current THDI	<u>0.0 .. 100.0%</u>	•	•	•	•	5 (EN 61557-12)
Harmonic amplitudes of voltage $U_{h2} \dots U_{h51}$, of current $I_{h2} \dots I_{h51}$	<u>0.0 .. 100.0%</u>	•	•	•		II (IEC61000-4-7)

tr_I - Current transformer ratio = Transformer primary current / Current transformer secondary current

tr_U - Voltage transformer ratio = Transformer primary voltage / Voltage transformer secondary voltage

¹⁾ Class 0.5 S acc. to EN 62053-22

Power consumption:

- in supply circuit ≤ 6 VA
- in voltage circuit ≤ 0.5 VA
- in current circuit ≤ 0.1 VA

Readout field

3.5" TFT full-color screen, resolution: 320 x 240 pixel

Relay outputs (A1, A2)

2 programmable relays, volt-free NO contacts, load capacity (resistive) 0.5 A/250 V AC or 5 A/30 V DC

Switching number: mechanical min. $5 \cdot 10^6$

electric min. 1×10^5

Analog output (0 .. 20 mA)

1 output: 0... 20 mA (4...20mA) programmable Load resistance $\leq 400 \Omega$. Voltage 10 V. Basic error 0.2%.

Inputs (T1, T2)

2 x Pt100, 2-wire, -50 ..+400 °C, basic error 0.5 %

Serial interface RS-485

Modbus RTU 8N2, 8E1, 8O1, 8N1. Address 1..247,

Baud rate 4.8, 9.6, 19.2, 38.4, 57.6, 115.2 kbit/s

Maximum response time: 600 ms

Ethernet interface

10/100 Base-T, RJ45 socket, web server. FTP Server

Modbus TCP/IP server, DHCP client

Sampling

A/D Converter 16-bit

sampling rate 6.4 kHz at 50 Hz

7.68 kHz at 60 Hz

Simultaneous sampling of all loops, 128 samples per cycle

Harmonics

Harmonic (n) 1..51

Harmonic distortion factor referred to the voltage THD, current THD (n=2..51) 0.0 ..100.0%

FFT analysis (Fast Fourier Transform)

Real Time Clock

± 20 ppm, real time clock battery CR2032

Registration

Archiving period (registration interval) 1..3600 sec.

Registration activation modes: n_on, noFF, on,oFF, H_on, HoFF, 3non, 3noF, 3_on, 3_oF,

Registration time: depends on the configuration e.g. approx. 220 days for interval 1 sec.

Files archive memory 8 GB

Terminals

Cross section	0.05 .. 2.5 mm ²
Clamping screws	M3
Tightening torque	0.5 Nm

Protection grade ensured by the housing

from the front	IP 65
from terminals side	IP 20

Weight 0.3 kg

Overall dimensions 96 x 96 x 77 mm

Reference and rated operating conditions

- supply voltage	 85..253 V a.c. (40.. <u>50</u> ..400 Hz), 90..300 V d.c. or 20..40 V a.c., 20..60 V d.c.
- input signal:	0 .. <u>0.1</u> .. <u>1.2</u> I _n ; 0.1.. <u>0.2</u> .. <u>1.2</u> U _n for current, voltage, PF _i , tg _i frequency 45 .. <u>50</u> .. <u>60</u> .. 65 Hz; sinusoidal (THD ≤ 8%)
- power factor	<u>-1</u> .. <u>0</u> .. <u>1</u>
- ambient temperature	-10.. <u>23</u> ..+55 °C, class K55 acc. to EN61557-12
- storage temperature	-20.. <u>+70</u> °C
- humidity	0 .. <u>40</u> .. <u>60</u> ..95% (no condensation)
- max. peak factor	
- current	2
- voltage	2
- external magnetic field	≤ <u>40</u> ...400 A/m DC ≤ 3 A/m AC 50/60 Hz
- short-term overload	
voltage inputs 5 sec.	2 U _n
current inputs 1 sec.	50 A
- working position	any
- warm-up time	15 min.

Real time clock battery: CR2032

Additional errors:

in % of the base error

- from ambient temperature changes < 50% / 10 °C
- for THD > 8% < 50%

Standards fulfilled by the meter:**Electromagnetic compatibility:**

- noise immunity in industrial environments acc. to EN 61000-6-2
radio-frequency common mode:
 - level 2: 0,15... 1 MHz
 - level 3: 1 MHz...80 MHz
- noise emission acc. to EN 61000-6-4

Safety requirements:

- according to EN 61010-1 standard
- isolation between circuits: basic
- installation category III for voltage to earth up to 300 V
- installation category II for voltage to earth up to 600 V
- pollution grade 2,
- maximum phase-to-earth operating voltage:
 - for supply circuits and relay outputs 300 V
 - for measurement input 500 V
 - for circuits RS-485, Ethernet, analog outputs: 50 V
- altitude a.s.l. < 2000 m,

14 ORDERING CODE

ND30IoT network parameters meter ordering code.

Table 23

ND30IoT Meter-	X	X	X	X	MQ	X	X
Input voltage (phase/phase-to-phase) Un							
3x 57, 7/100 V, 3x 230/400 V	1						
3x 110/190 V, 3x 400/690 V	2						
Additional outputs/inputs							
2 relays		1					
2 relays, 1 analog output, 2 Pt100 inputs		2					
Interfaces							
RS485 and Ethernet interface, internal memory file system			2				
Supply voltage:							
85..253 V a.c., 90..300 V d.c.				1			
20..40 V a.c., 20..60 V d.c.				2			
Version							
MQTT					MQ		
Language version							
Polish						P	
English						E	
other*						X	
Acceptance tests							
without extra requirements							0
with quality inspection certificate							1
acc. to customer's request*							X

* only after agreeing with a manufacturer

ORDERING CODE EXAMPLE, the code **ND30IoT-1 2 2 1 MQ E 0** means:

- ND30IoT** – ND30IoT meter,
- 1** – input voltage 3 x 57.7/100 V, 3 x 230/400 V,
- 2** – 2 relays, 1 analog output 0..20 mA, 2 inputs Pt100
- 2** – RS-485 and Ethernet, internal memory file system
- 1** – supply voltage: 85..253 V a.c., 90..300 V d.c.
- MQ**– MQTT version
- E** – English language version
- 0** – without extra requirements.



LUMEL S.A.

ul. Sulechowska 1, 65-022 Zielona Góra, POLAND

tel.: +48 68 45 75 100, fax +48 68 45 75 508

www.lumel.com.pl,

e-mail: lumel@lumel.com.pl

Export department:

tel.: (+48 68) 45 75 139, 45 75 233, 45 75 321, 45 75 386

fax.: (+48 68) 32 54 091

e-mail: export@lumel.com.pl